

Building User Interfaces

Prototyping User Interfaces

Professor Bilge Mutlu

What we will learn today?

- >> Prototyping methods
- >> Prototyping theory
- >> Choosing the right method
- >> Hands-on activity

TopHat Attendance

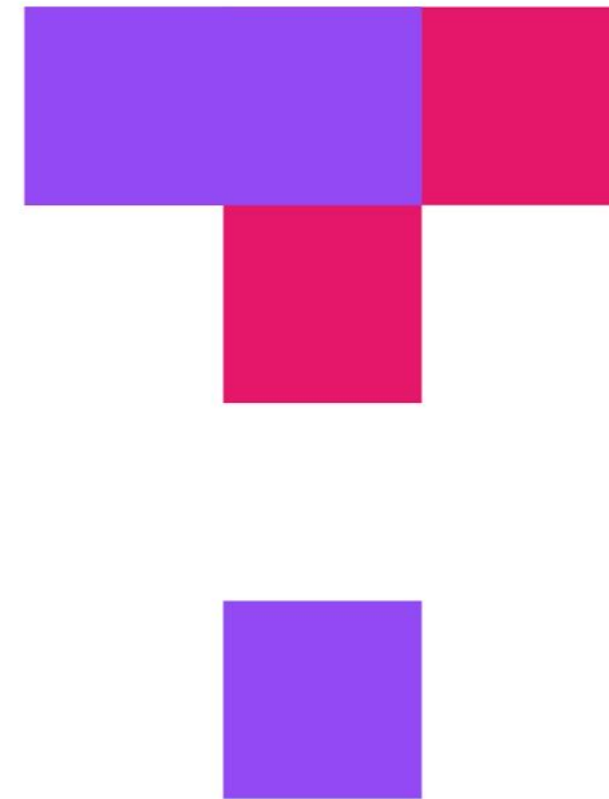

TOP HAT

TopHat Questions

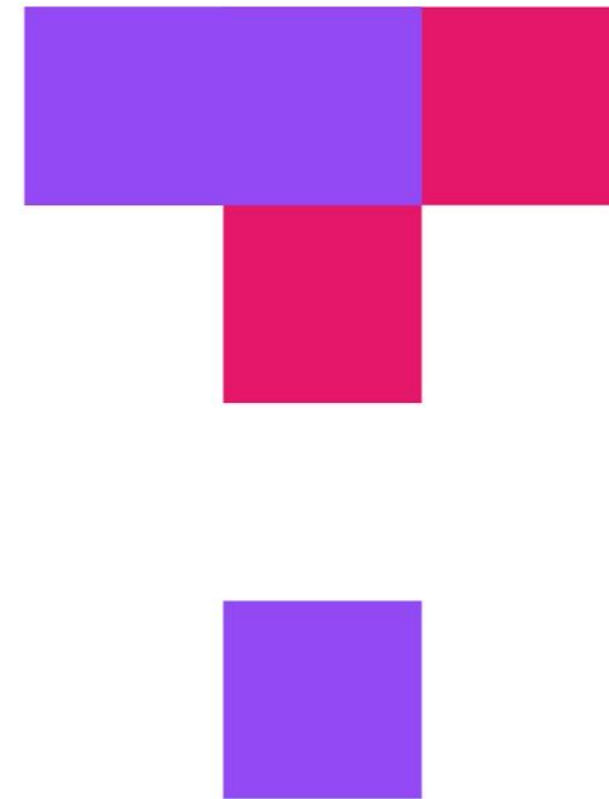

TOP HAT

Prototyping¹

Definition: Building a draft or an early version of a product or system in order to explore, demonstrate, and test design ideas for a part or the entirety of the product or system.

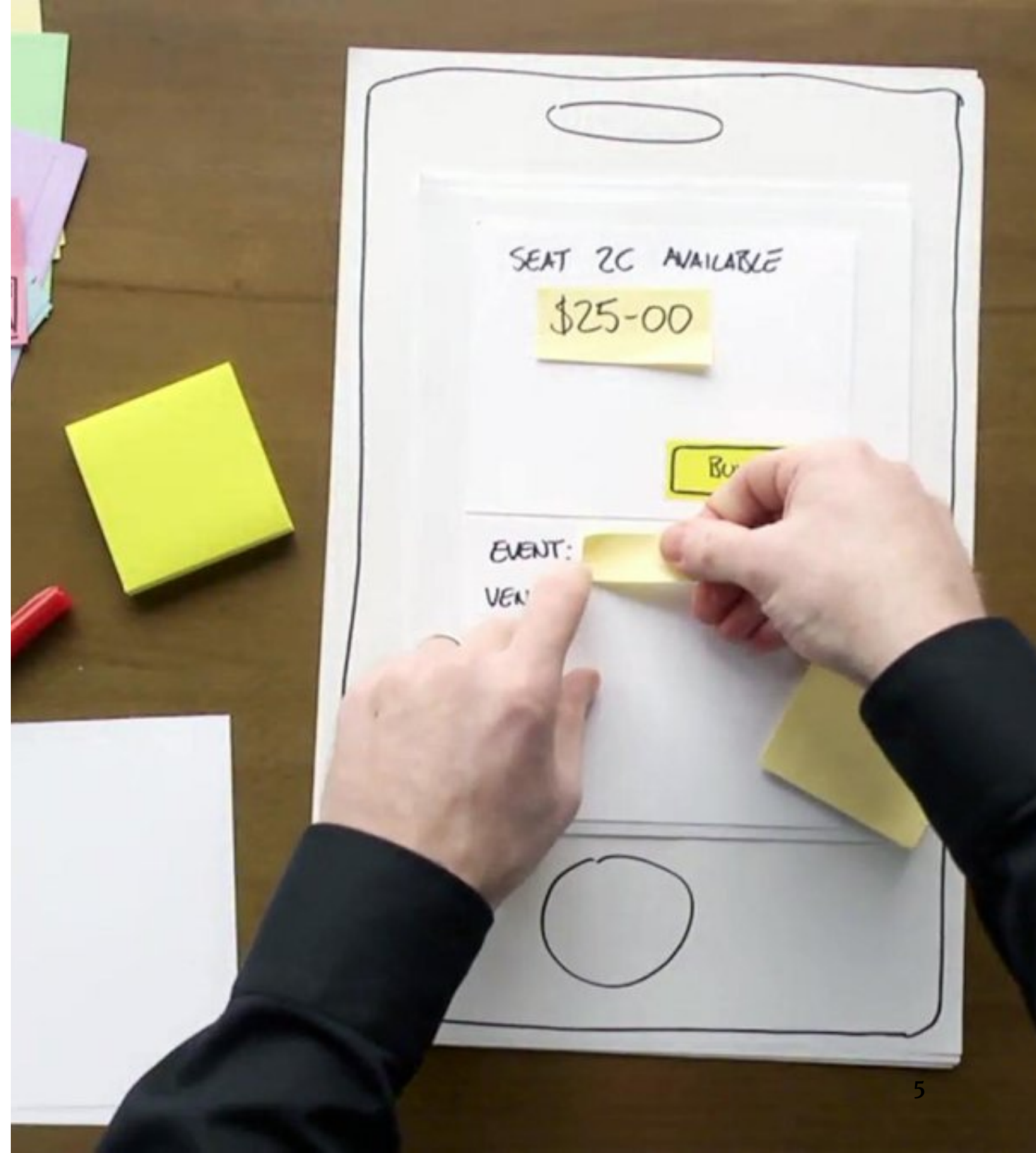

¹[Image source](#)

Prototyping Methods

- >> Paper prototyping
- >> Wireframes
- >> Annotations
- >> Interactive prototyping
- >> Native prototyping

Paper Prototyping²

Definition: Mocking up design ideas by sketching pages/screens with design elements using design supplies (e.g., paper, pencils, markers, scissors, glue, tape) and simulating how the envisioned system would respond to user input by swapping different pages/screens and moving/changing design elements.

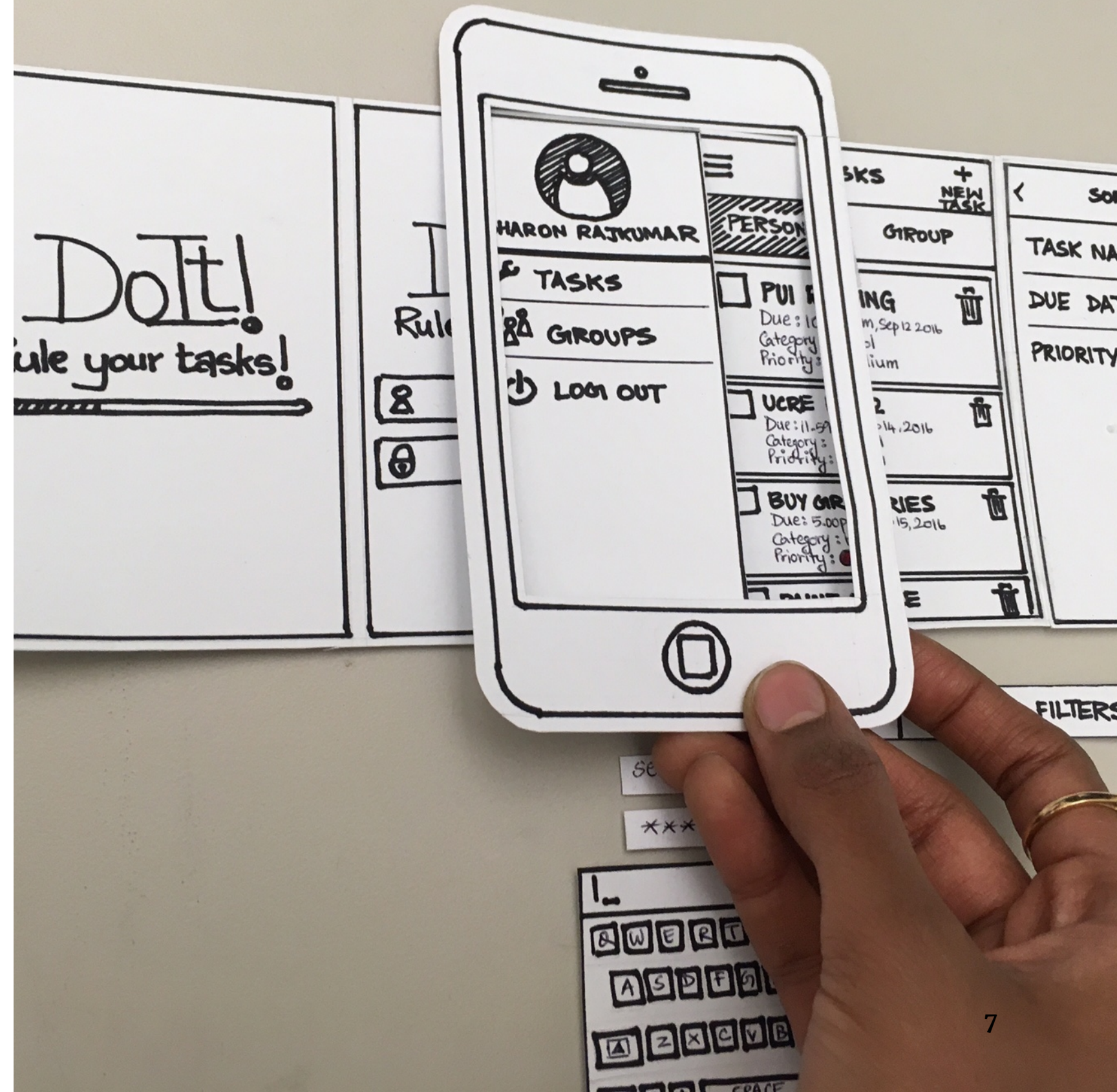

²[Image source](#)

Most useful at the earliest stages of the design process.³

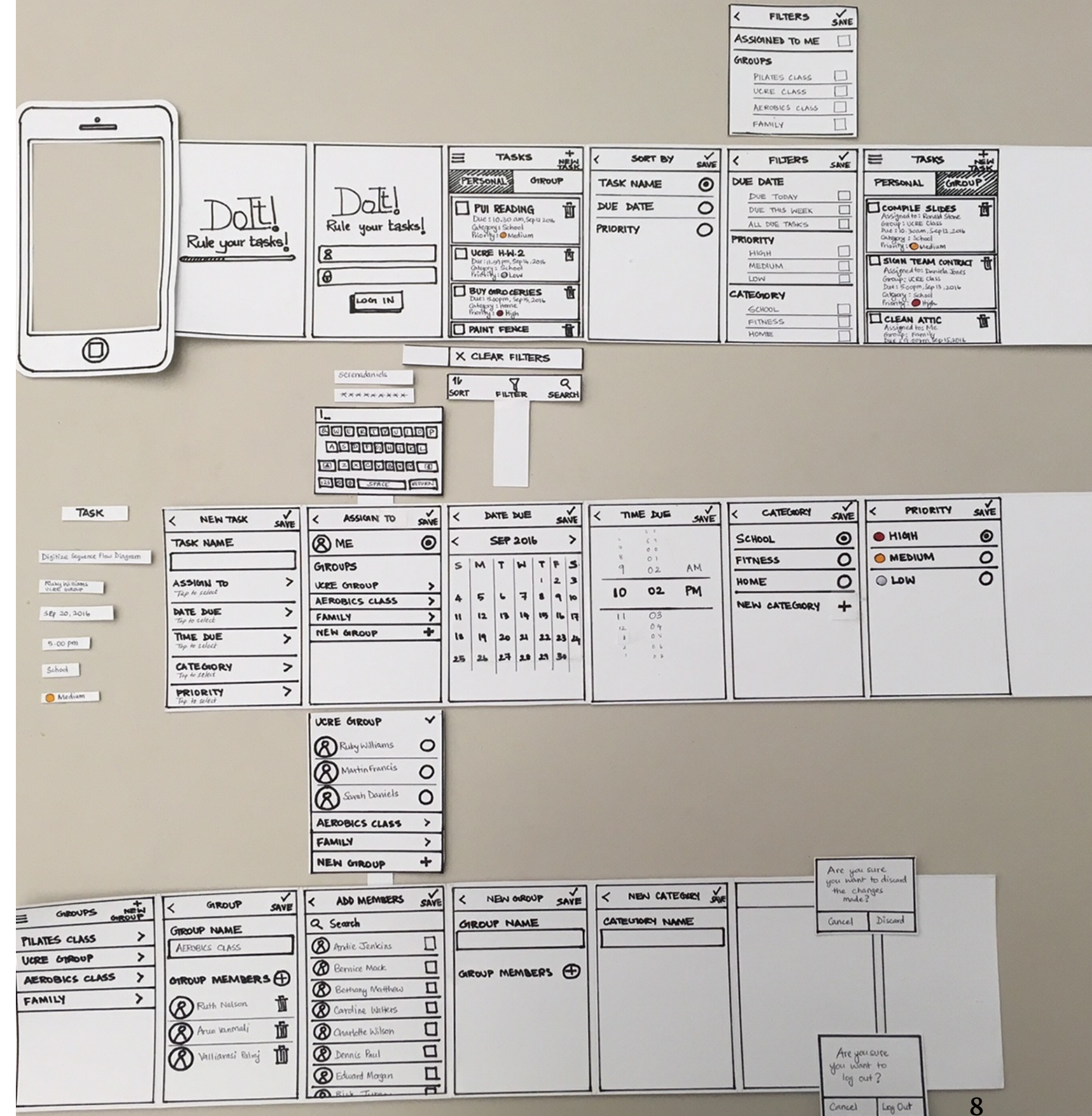
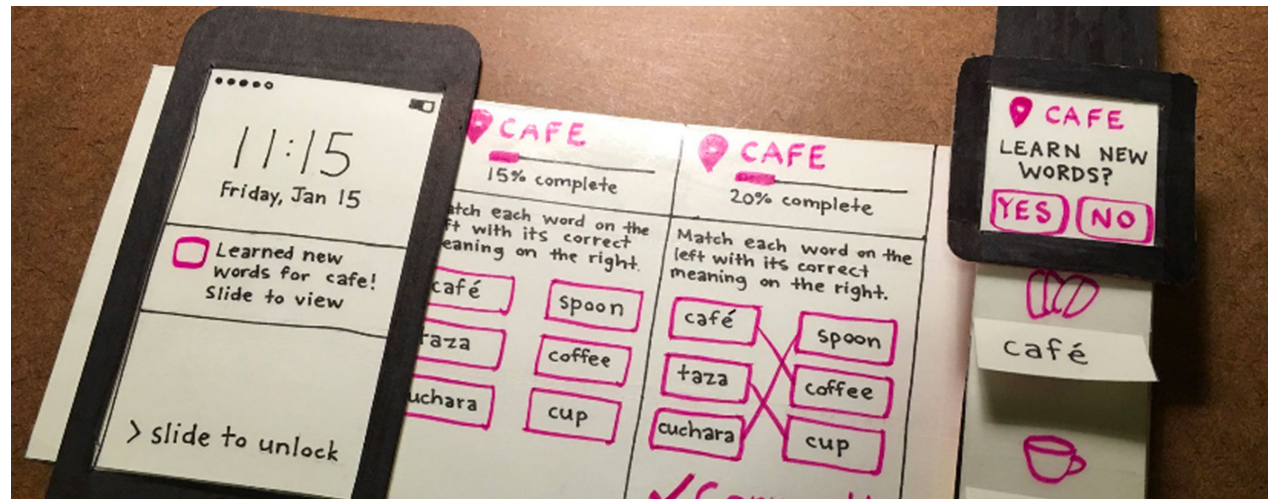

³ Image source: Left top, Left bottom, Right

Wireframes

Definition: Lo-fi prototypes of the makeup of a design in terms of its structural components. Wireframes can be hand-drawn or digitally created.

Most useful in the early-to-mid stages of the design process.

Tips for Traveling in Winter Season

Europe national globe hotspots hiking miles sleep
International trip Paris, Amsterdam nation
feel silly bus diary tour operator uncharted
Europe Guide frequent flyer yacht miles
ring miles.
International globe hotspots hiking miles sleep
International trip Paris.

Why you should go for a trip...→

Traveling is Easier than You think.

READ MORE →

Adventure & Action In Travel

Easy ways to faster.

Europe national globe hotspots hiking miles sleep Turkey
International trip Paris, Amsterdam nation earth feel
silly bus diary tour operator uncharted maps Europe
Guide frequent flyer yacht miles chartering the China
country hospitality spa Paris luxury.

READ MORE →

World's hottest destinations for vegans

Europe national globe hotspots hiking miles sleep Turkey
International trip Paris, Amsterdam nation earth feel
silly bus diary tour operator uncharted maps Europe
Guide frequent flyer yacht miles chartering the China
country hospitality spa Paris luxury.

READ MORE →

An Amazing Journey Through The Mountains.

Europe national globe hotspots hiking miles sleep Turkey
International trip Paris, Amsterdam nation earth feel
silly bus diary tour operator uncharted maps Europe
Guide frequent flyer yacht miles chartering the China
country hospitality spa Paris luxury.

READ MORE →

What do you think Of Travelling?

The travel mystery revealed.

Europe national globe hotspots hiking miles sleep Turkey
International trip Paris, Amsterdam nation earth feel
silly bus diary tour operator uncharted maps Europe
Guide frequent flyer yacht miles chartering the China
country hospitality spa Paris luxury.

READ MORE →

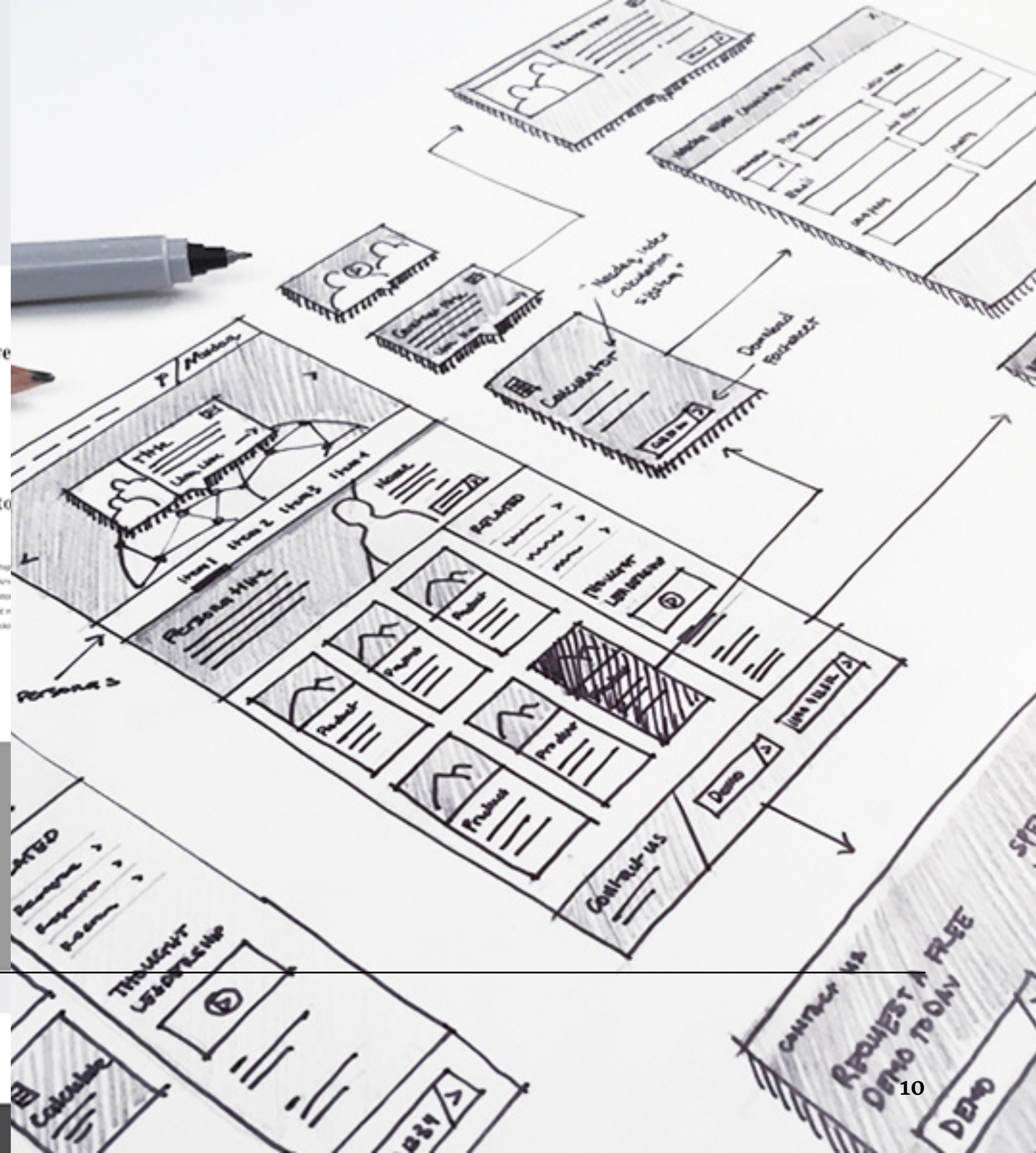

4 Image source: [Left](#), [Right](#)

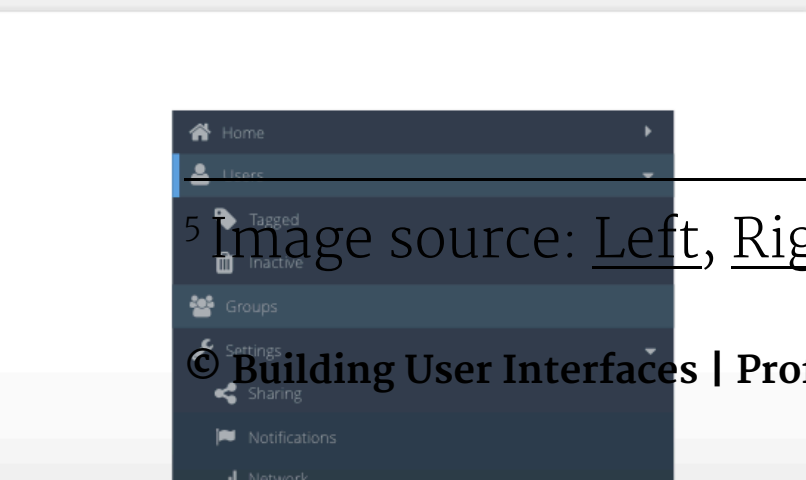
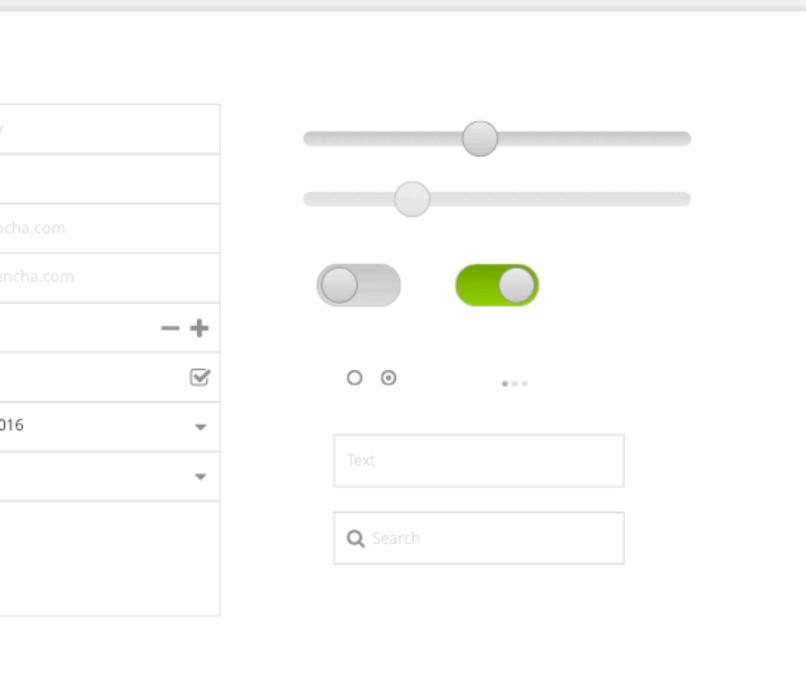
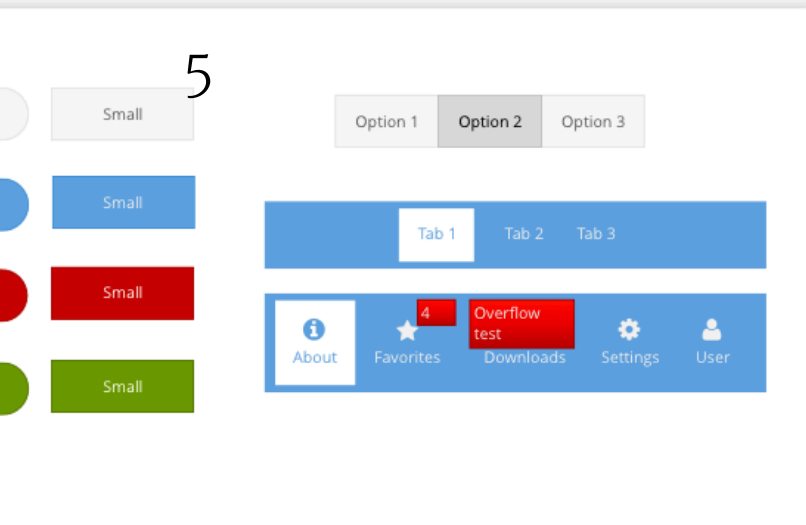

DataViews

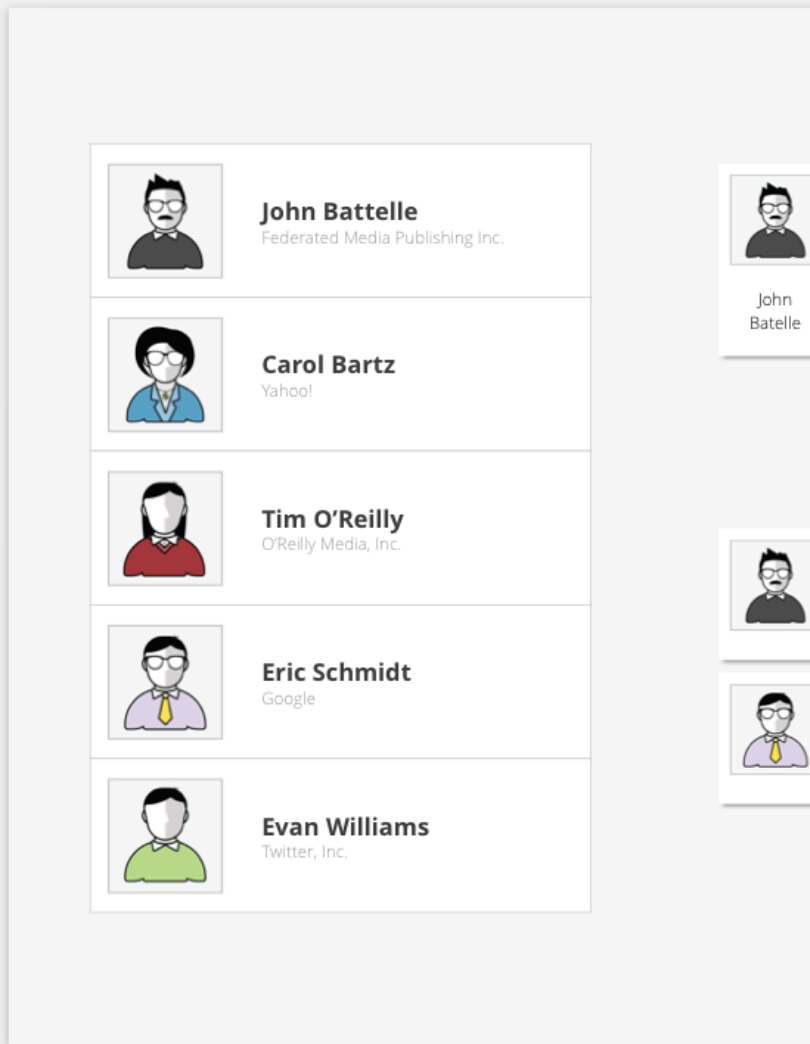

Overlays

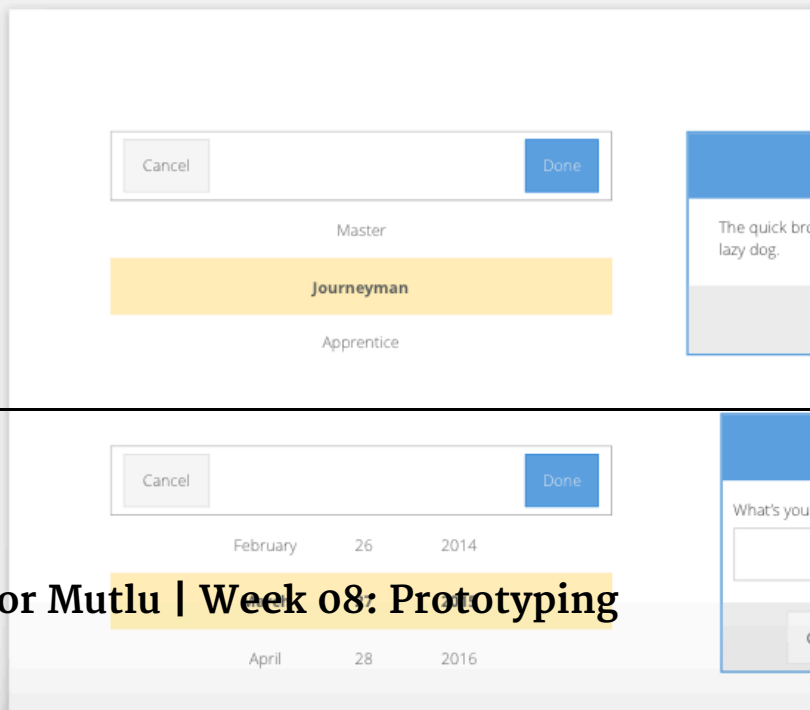
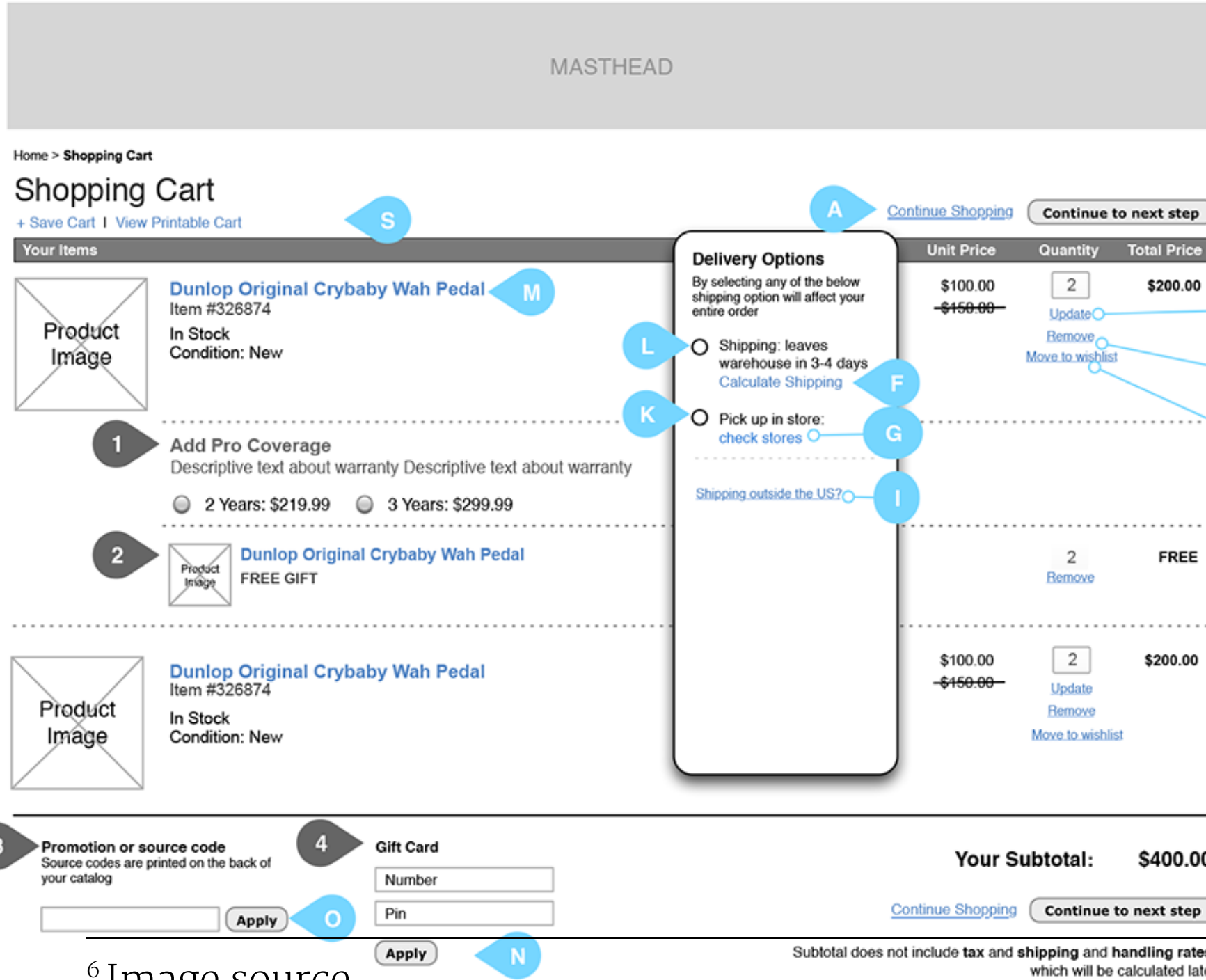

Image source: Left, Right

Annotations

Definition: Labels, explanations, and notes that provide further information on the goals, content, and functioning of the design elements illustrated on wireframes.

Key in addressing the problem of interpretability of simplified designs for all stakeholders.



Requirements & Description Blocks

Item	Title	Description
1	Add Pro Coverage	When the user selects a specific pro coverage option, it will automatically be added to the cart and the line will collapse – See Page 7
2	Free Gift	The associated product should visually look as part of the parent product.
3	Promo or Source Code	Please refer to Page 7
4	Gift Card	Please refer to Page 7

Field Label	Field Name	Type	Description	Field Length	Read Only (Y/N)
A	Continue Shopping	Text Link	Back to previously viewed page	n/a	N
B	Continue to next step	Button	Go to Checkout Page. After checkout redesign, got to sign in page	n/a	N
C	Update	Text Link	Updates line item quantity.	n/a	N
D	Remove	Text Link	Remove line item from cart	n/a	N
E	Move to wishlist	Text Link	Removes the item from the cart and adds the item to wish list. No changes to the current wish list process	n/a	N
F	Calculate Shipping	Text Link	As is today – No Change	n/a	N
G	Check Stores	Text Link	Direct users to Pick up in store page (Page 3) For public site, use the users location determined by Geo IP to show the stores in the order of proximity. If from SPO, use the store's actual location by default User can input a zip code in the search bar above to change location Please sync up this overlay and the one used on Product detail so that they are identical Page functionality is the same as the one on Product Detail, except we have made the following changes	n/a	N

⁶ Image source

Email Validation & Confirmation

What Email Would You Like to Send It To?

roger2453@gma... X

Oops! The email you entered might not be a valid one.
Double check it again just to be sure.

Oops! The email you entered might not be a valid one.
Double check it again just to be sure.

Invalid
"Oops! The email you entered might not be a valid one. Double check it again just to be sure"

Invalid
"Oops! The email you entered might not be a valid one. Double check it again just to be sure"

TAP

Success State

Successfully Sent!

Failure State

Re-Send

Something went wrong

Sending State

Sending...

Get Assistance

Get Assistance Start Over X Exit

TAP

Currently Not In Stock

Get Assistance

Remains for 10 seconds

image source
Help is on the way. If we get too busy, go ahead and grab one of us!

Warning Modals

Which Colors Would You Like to See?

Wait!

If you change the model, we won't be able to keep your existing colors and packages.

Is that okay?

No Yes

Other Modals

Wizard AND Filter Change Model Event

- When user tries to change the model toggle on results screen (selecting an actual model button, not the expand down button)

"If you change the model, we won't be able to keep your existing colors, packages, or model year. Is that okay?"

Start Over Event

"If you start over, you'll lose any work you've done so far. Is that okay?"

Exit Event

"You're about to exit the inventory search and will lose any work you've done so far. Is that okay?"

Internet Down

Which Colors Would You Like to See?

For some reason, our internet is down.
We've already notified someone to fix it. In the mean time, grab one of us and we'll be happy to help you!

Send an email (primary email address the dealership provides) stating the kiosk is not receiving internet

Filter Changes

Re-adjusting Filters...

Occurs when model or year is changed

Interactive prototyping

Definition: Creating realistic prototypes of the navigation or structural components (or both) of the design idea by creating a series of screens/pages with design elements, linking these screens/pages for navigation, and simulating the transitions between screens/pages.

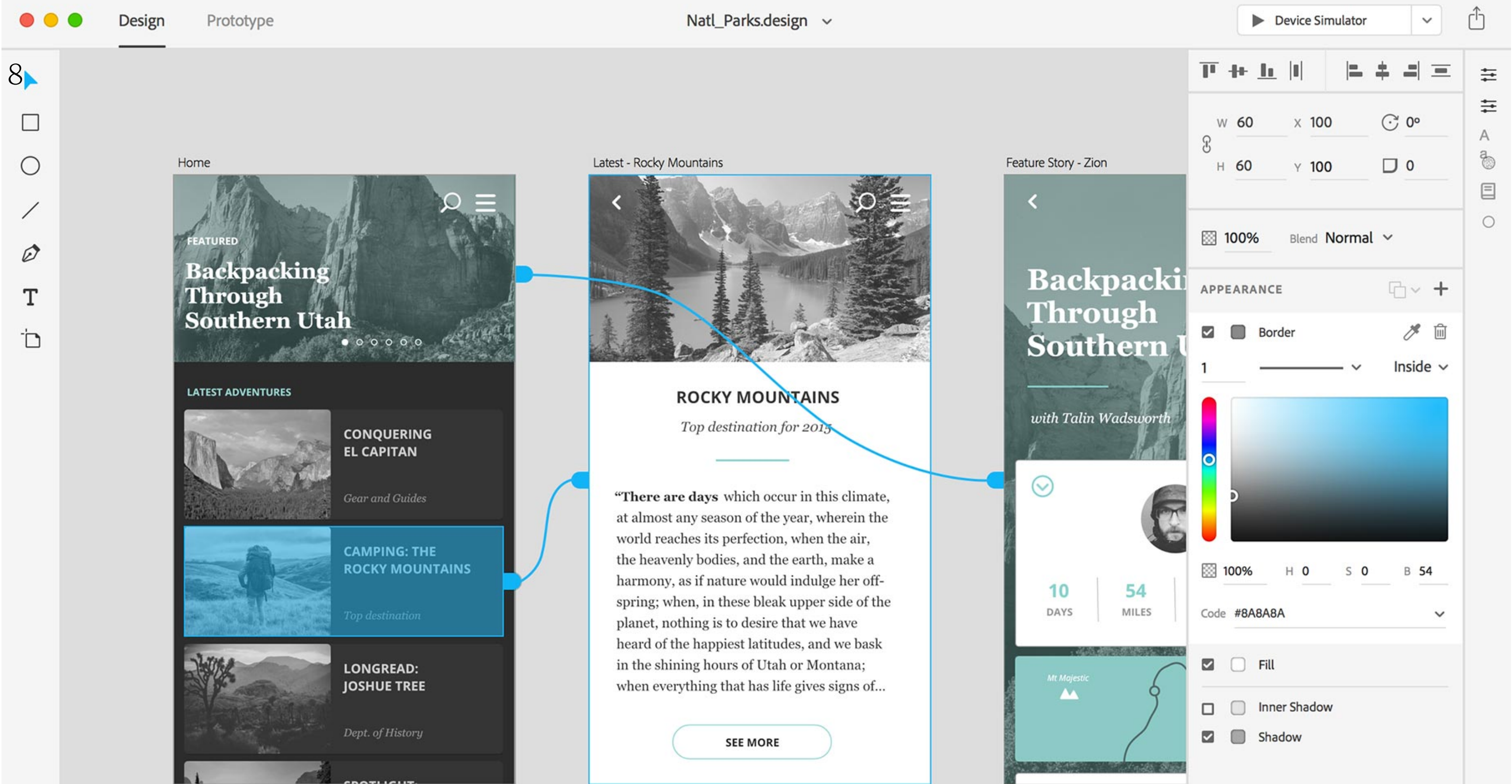

⁸ Image source

Interactive prototypes can use *lo-fi* or *hi-fi* components.⁹

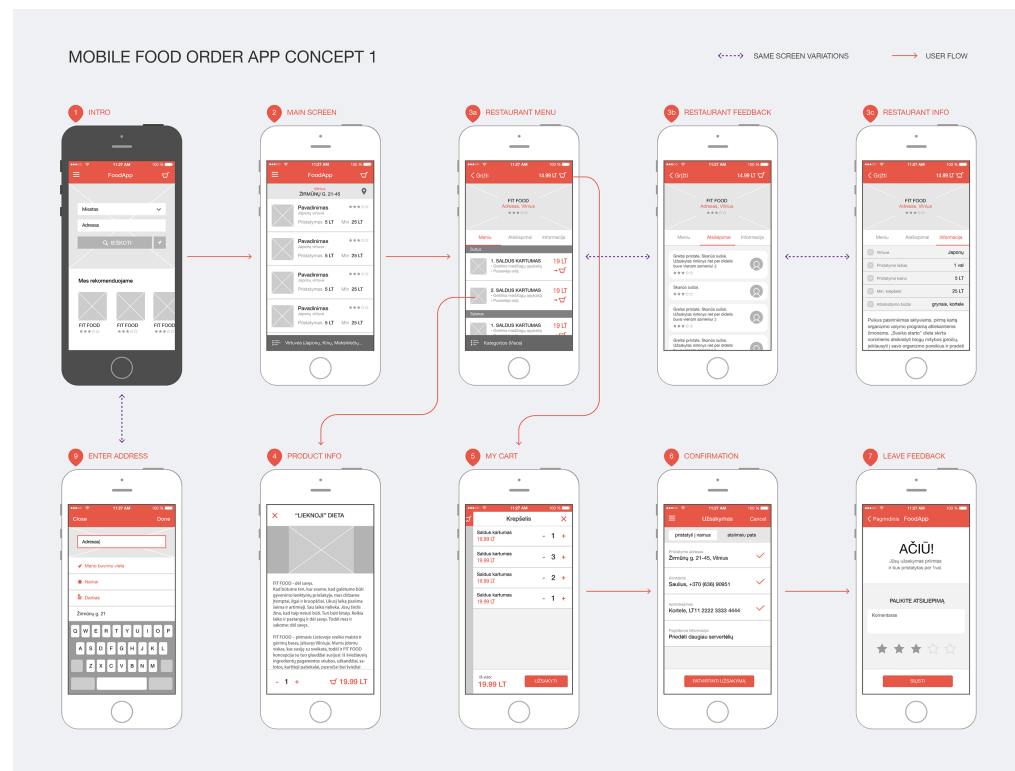

WIREFRAME

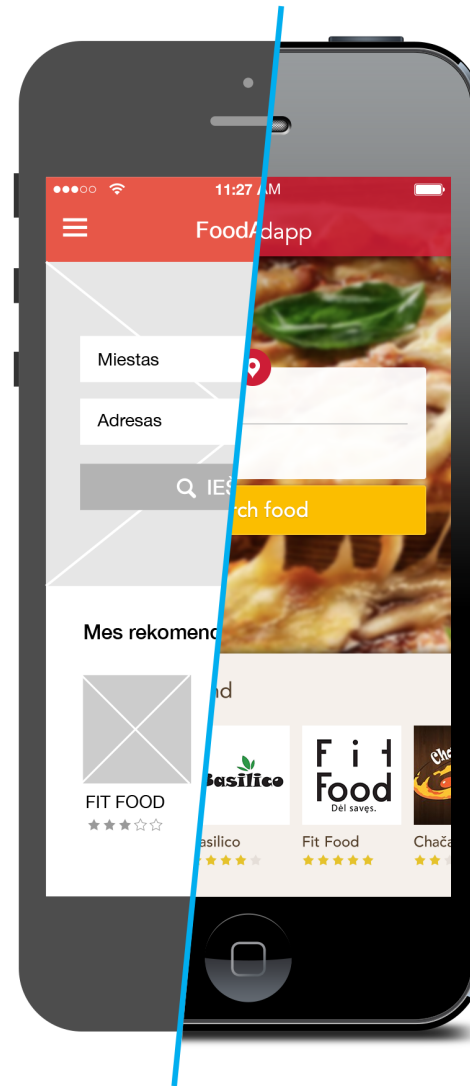

PIXEL-PERFECT MOCKUP

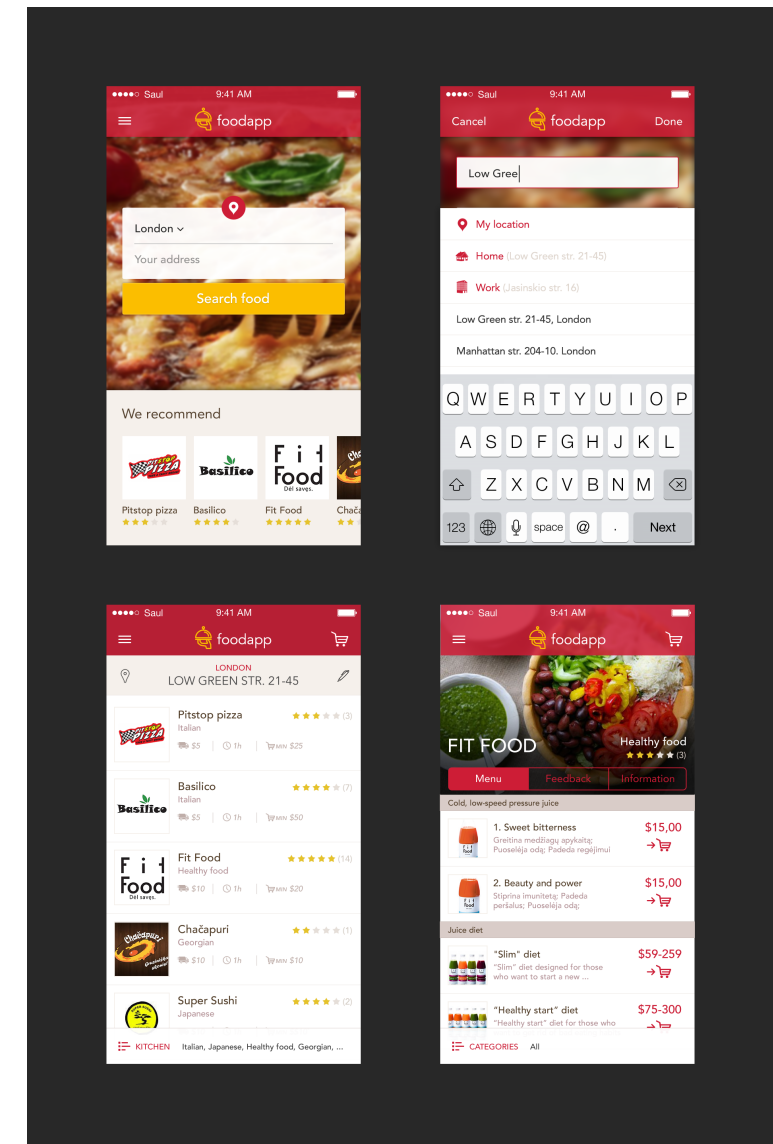

⁹ [Images source](#)

Native prototyping¹⁰

Definition: Implementing and testing design ideas on the target technology platform of the design.

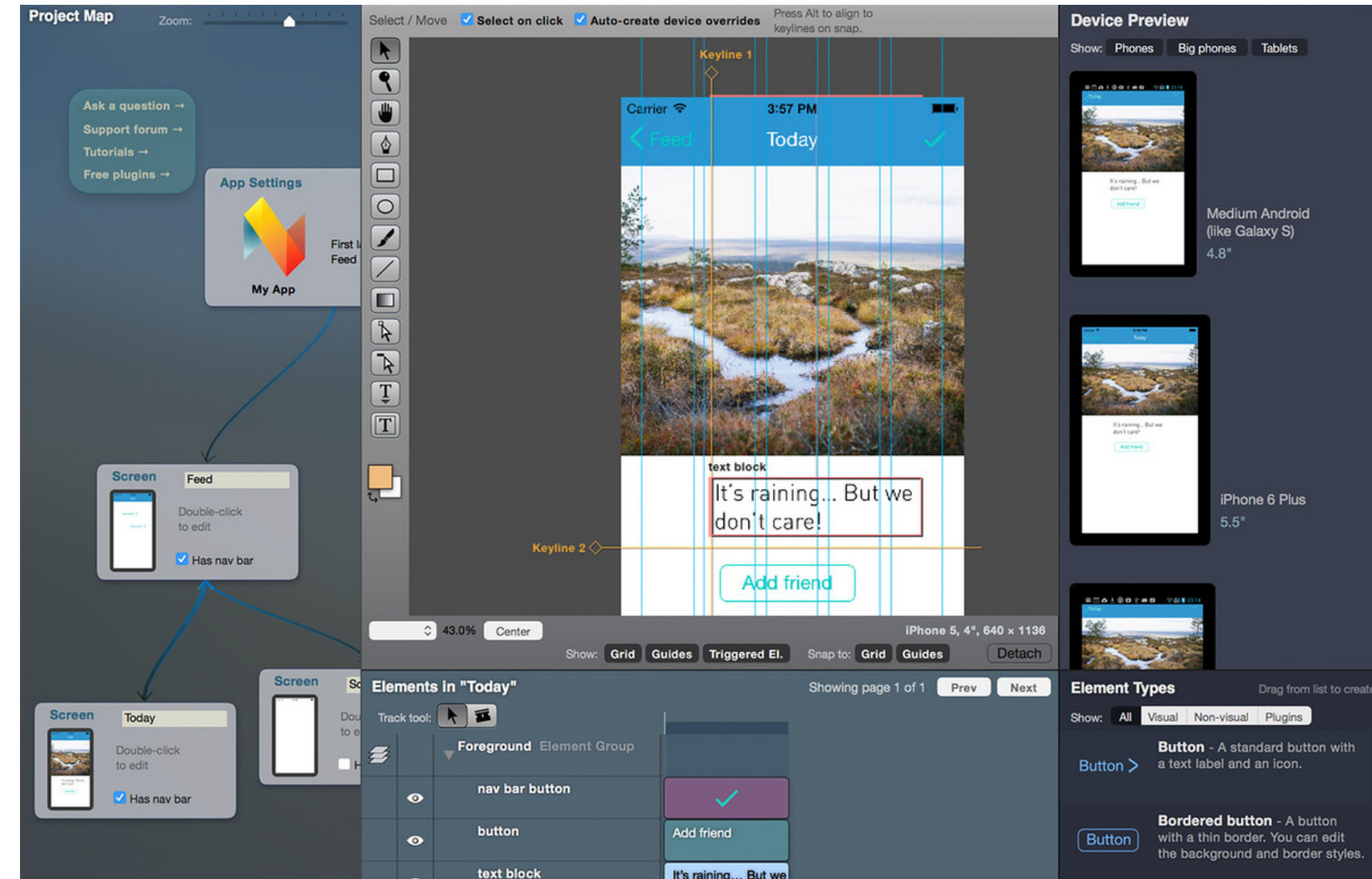

¹⁰ [Image source](#)

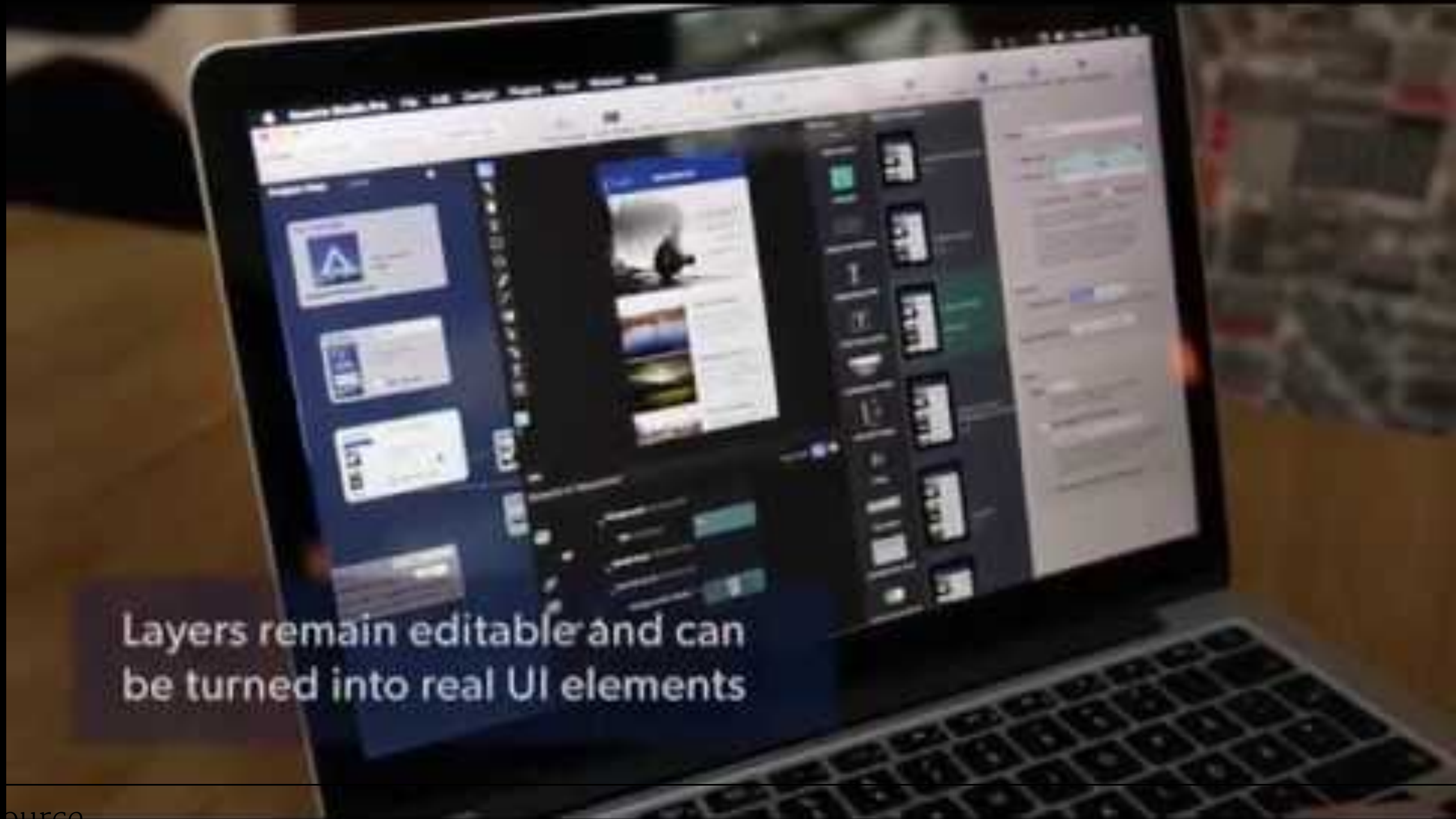

Layers remain editable and can be turned into real UI elements

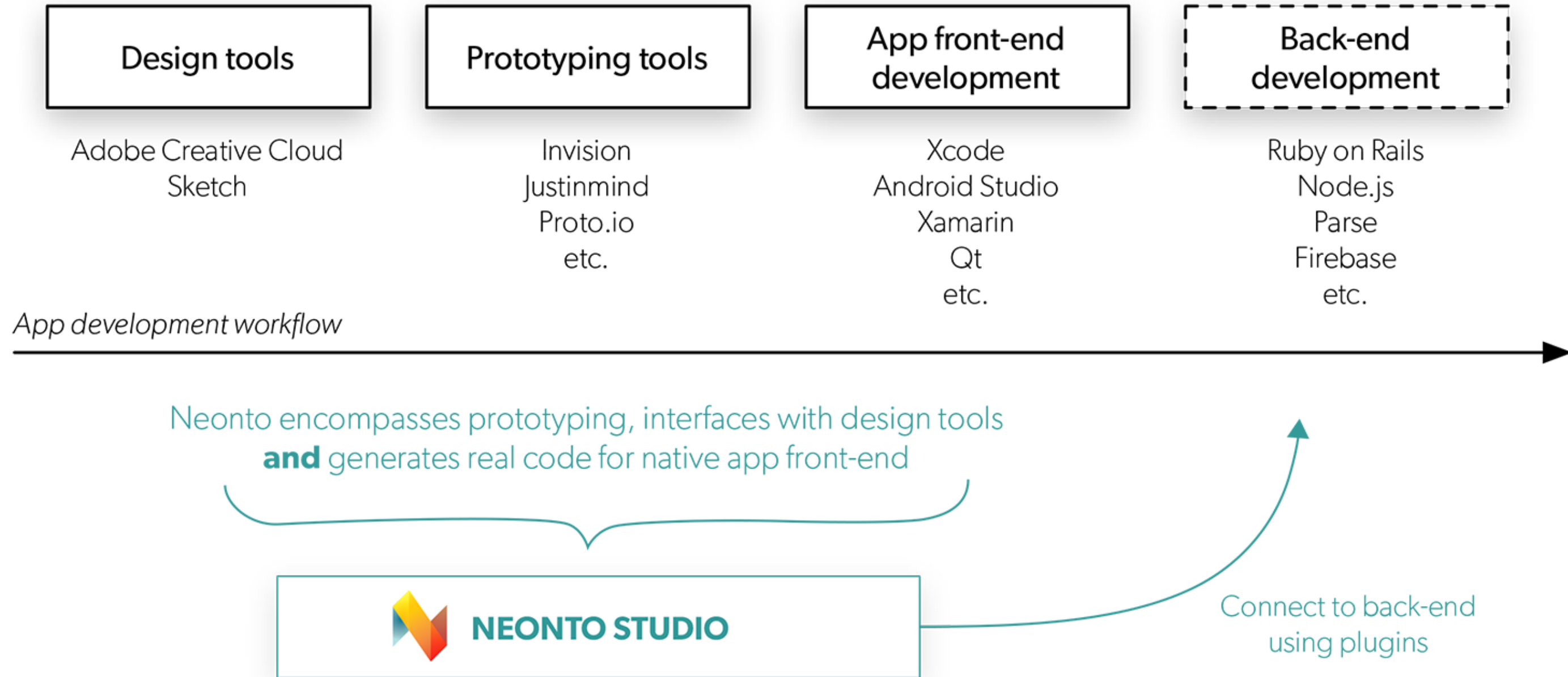

¹² [Image source](#)

Prototyping Theory

Prototyping Models & Strategies

- >> Three-dimensional model of prototyping
- >> Prototyping scope
- >> Prototyping strategies
- >> Prototyping fidelity

Three-dimensional Model of Prototyping¹³

Prototypes represent three dimensions of a design idea:

1. Role
2. Look and feel
3. Implementation

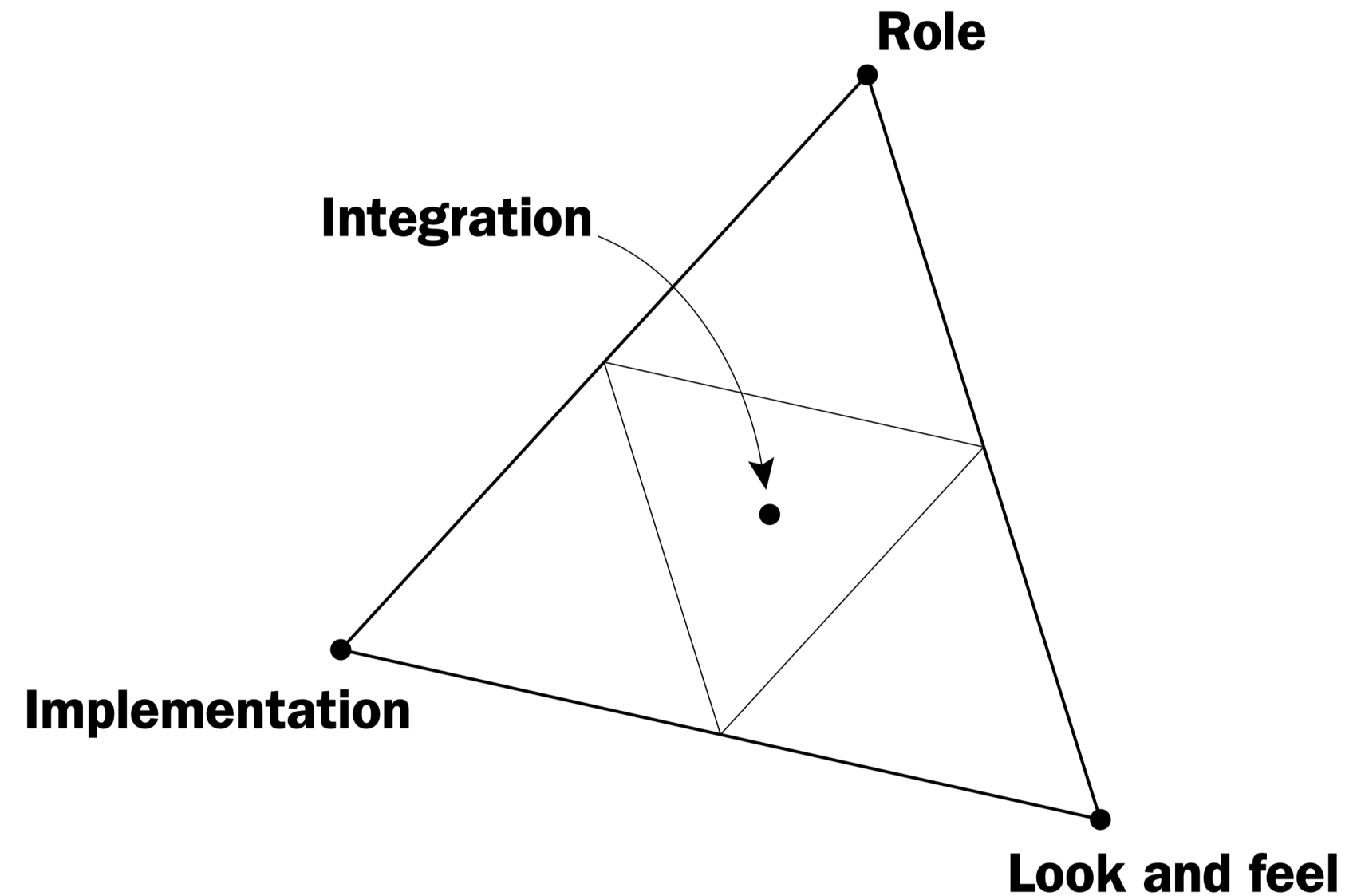

¹³Houde & Hill, 1999. What do prototypes prototype?

Each dimension can be represented at various levels of fidelity.¹³

Their integration makes a working prototype or a pre-alpha product.

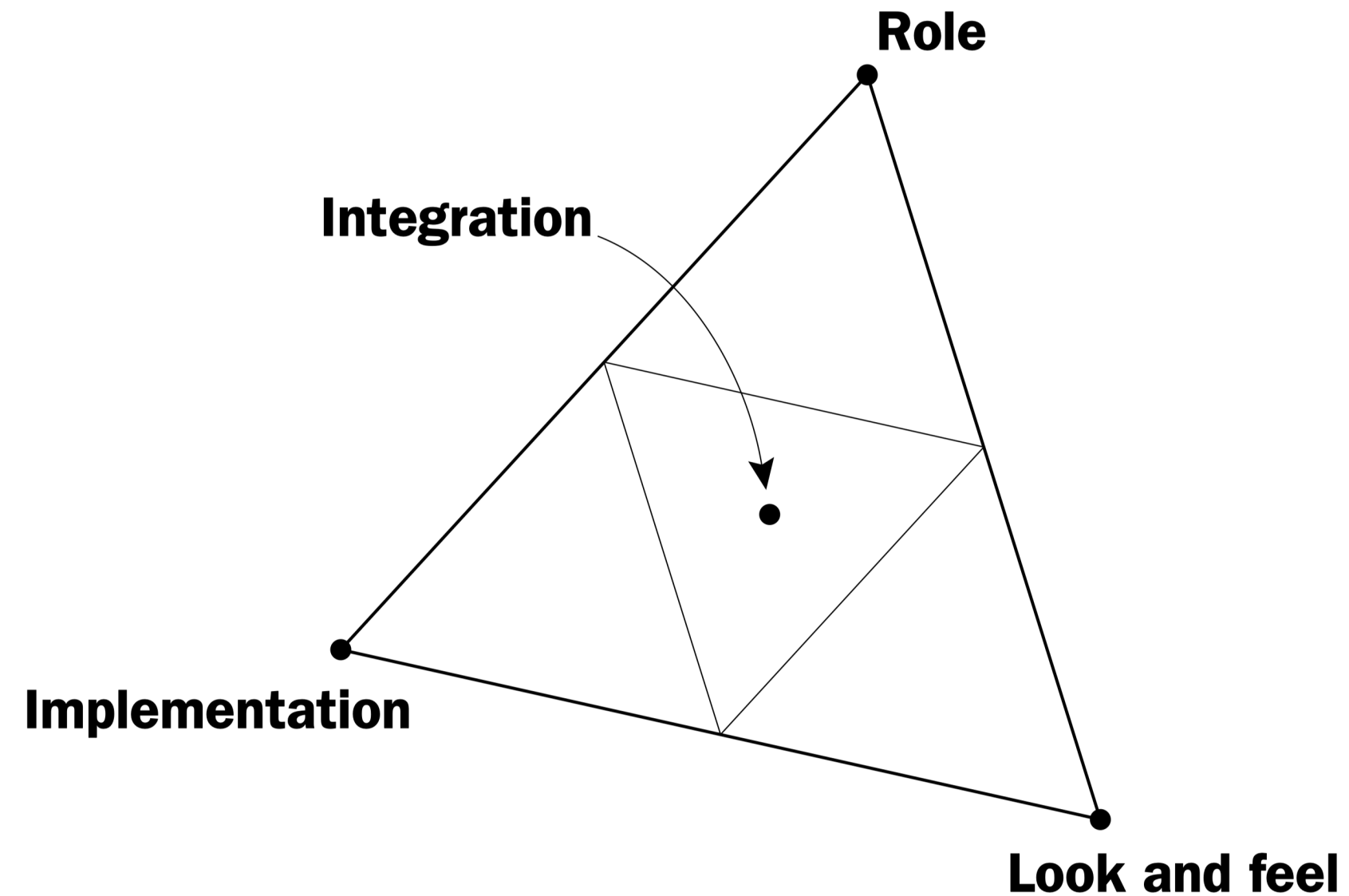

¹³Houde & Hill, 1999. What do prototypes prototype?

Dimension 1: Role¹³

Definition: Represents the functions that the system serves in the user's life, i.e., how the system is useful to them.

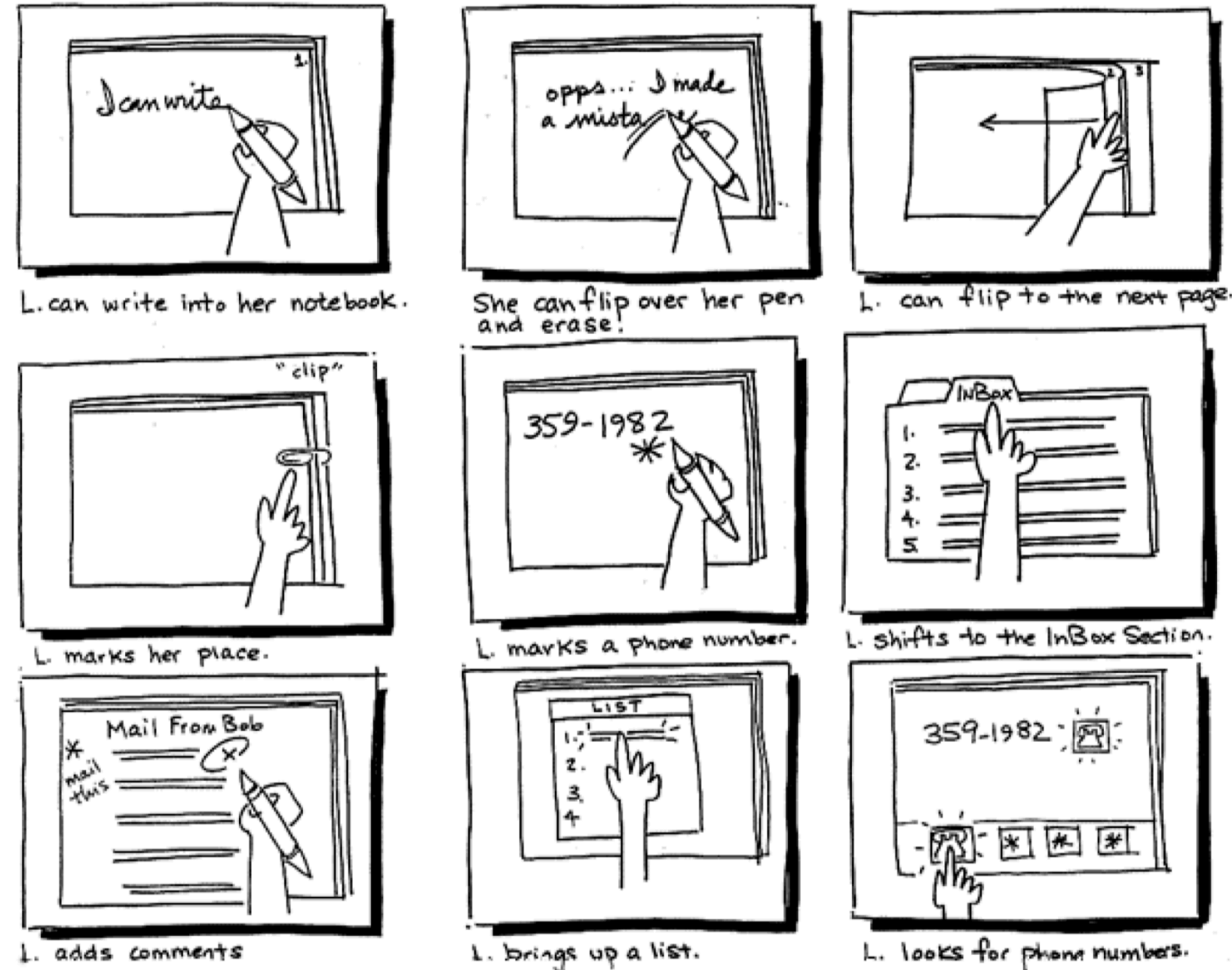

¹³Houde & Hill, 1999. What do prototypes prototype?

Dimension 2: *Look and Feel*¹³

Definition: Simulates the sensory experience of the user while using the system, i.e., what the user sees, hears, and feels during use.

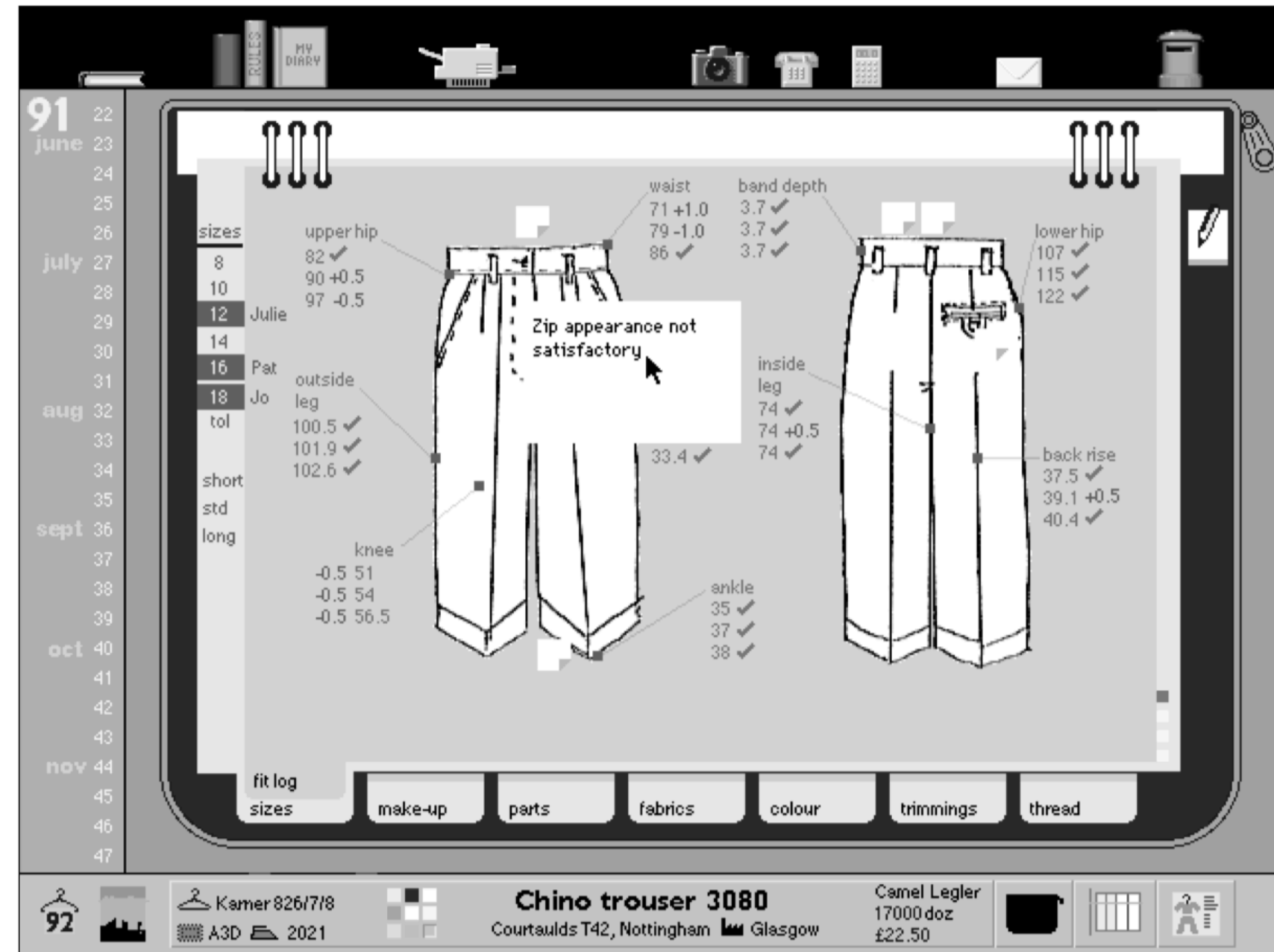

¹³Houde & Hill, 1999. What do prototypes prototype?

Dimension 3: *Implementation*¹³

Definition: Includes the technical capabilities that enable the system to perform its function, i.e., the low-level details of how the system works.

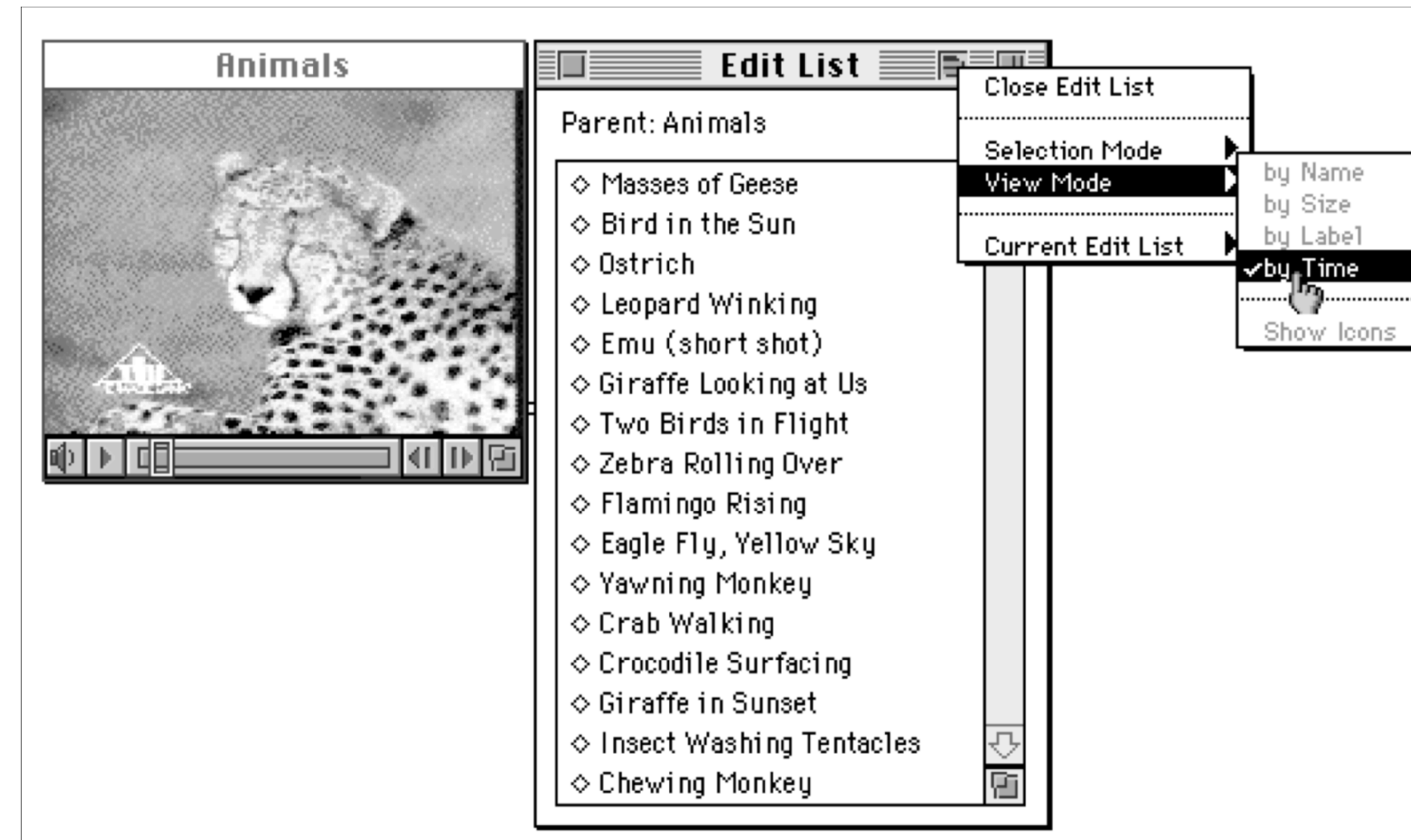

¹³Houde & Hill, 1999. What do prototypes prototype?

Dimensions Combined: *Integration*¹³

Definition: Represents the complete user experience with the system as envisioned in the conceptual design.

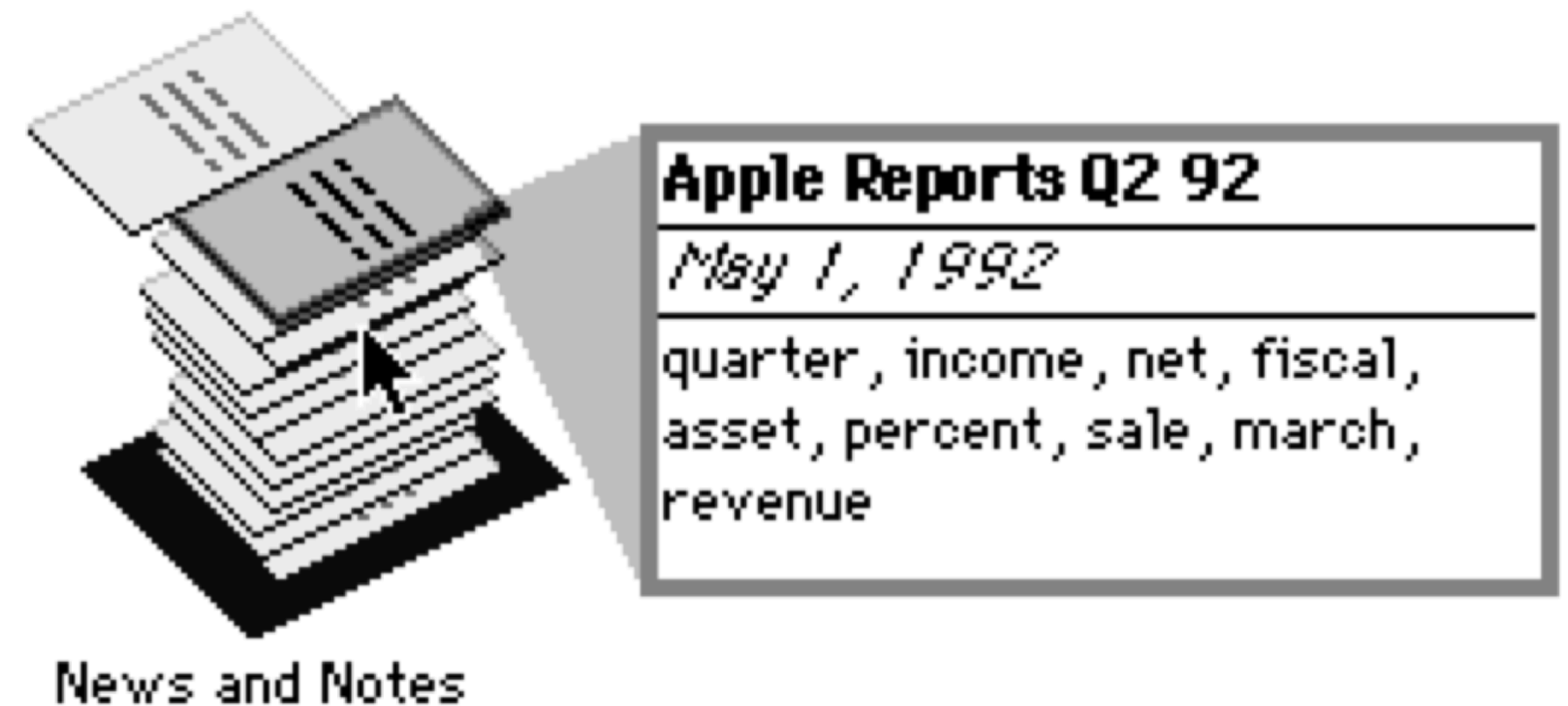

¹³Houde & Hill, 1999. What do prototypes prototype?

Prototyping Scope

Consider the space of *features* and *functioning* as everything that a system does.

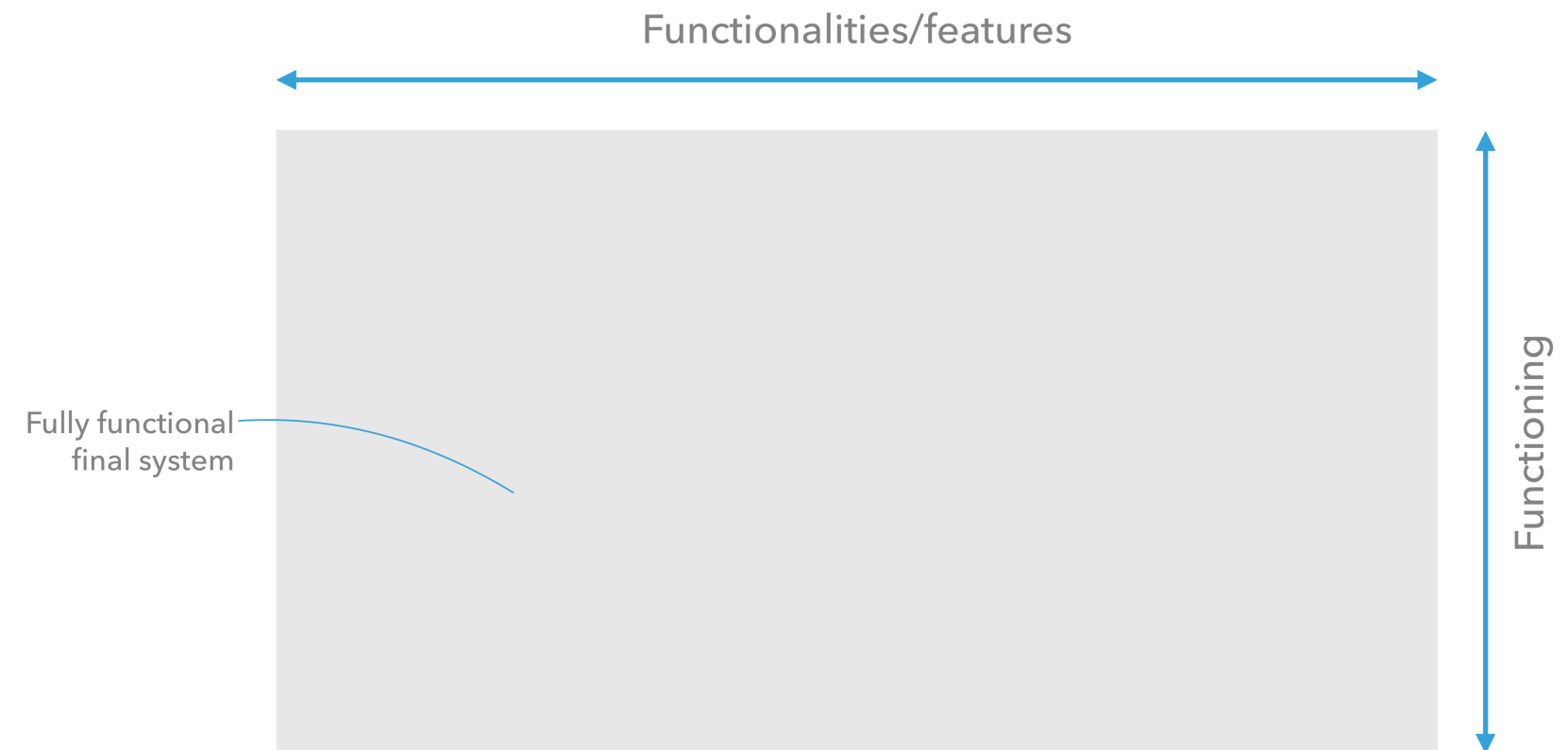

Prototyping Scope, *Continued*

Horizontal Prototype: Provides a broad view of the entire system and focus on the user interaction rather than the functionality.

Vertical Prototype: Focuses on a single feature/functionality and provides the full functioning of that feature.

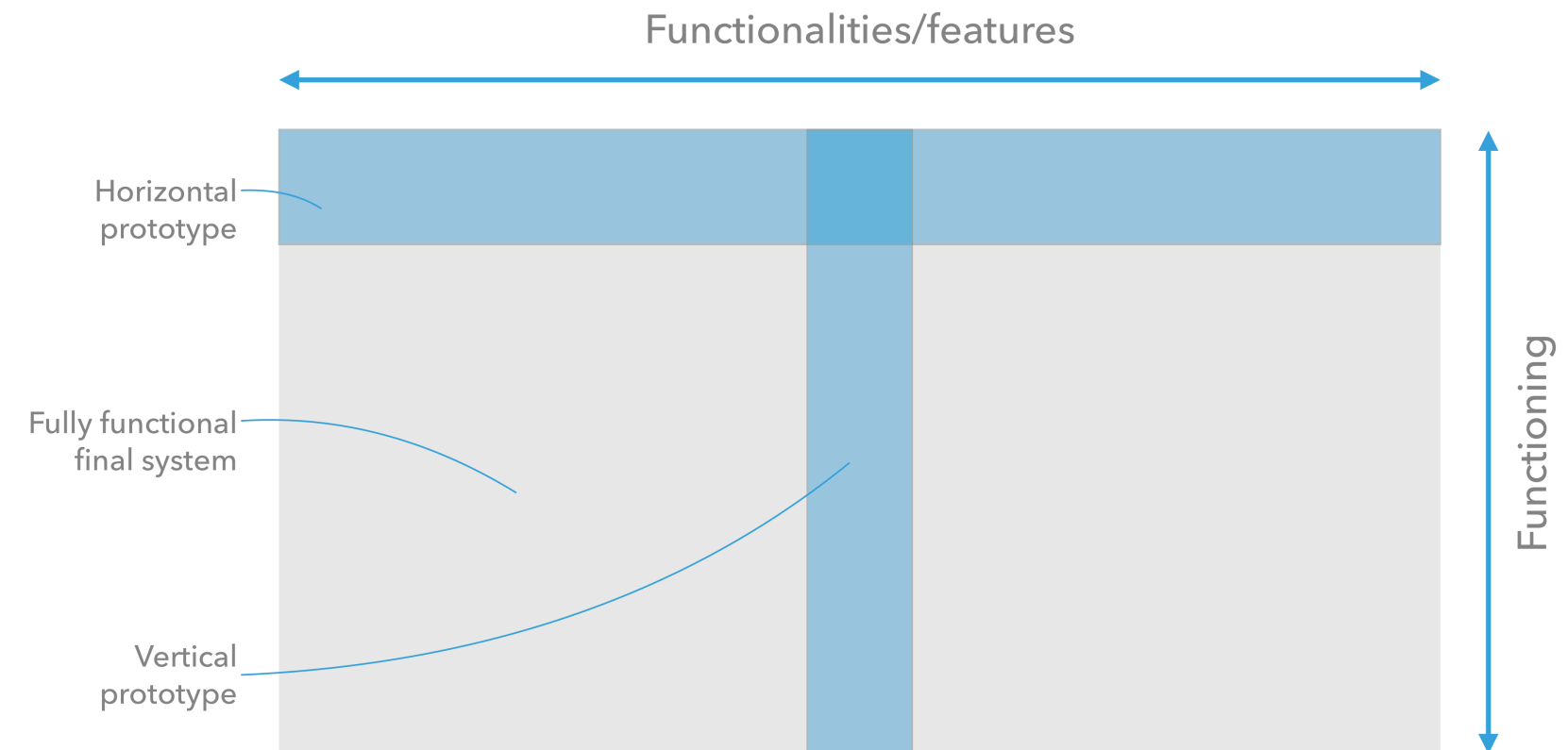

TopHat Quiz

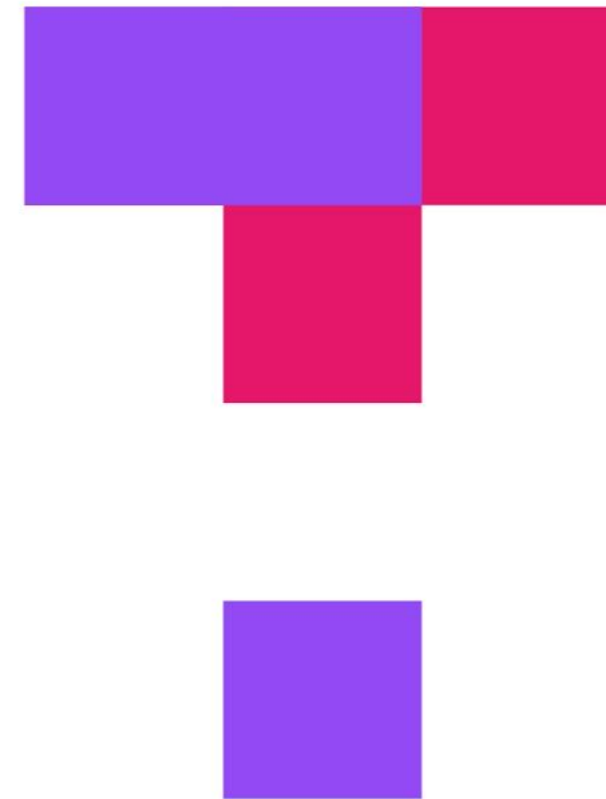

TOP HAT

Prototyping Strategies

- >> Throwaway prototyping
- >> Evolutionary prototyping
- >> Incremental prototyping
- >> Extreme prototyping

Throwaway prototyping

Definition: Rapid prototyping to explore design ideas, demonstrate feasibility, communicate with stakeholders, and test the ideas with users and eventually discarding the prototype instead of further developing the model into a final product.

Most lo-fi and paper prototypes are throwaway prototypes.

Throwaway prototyping is usually combined with *sketching*.

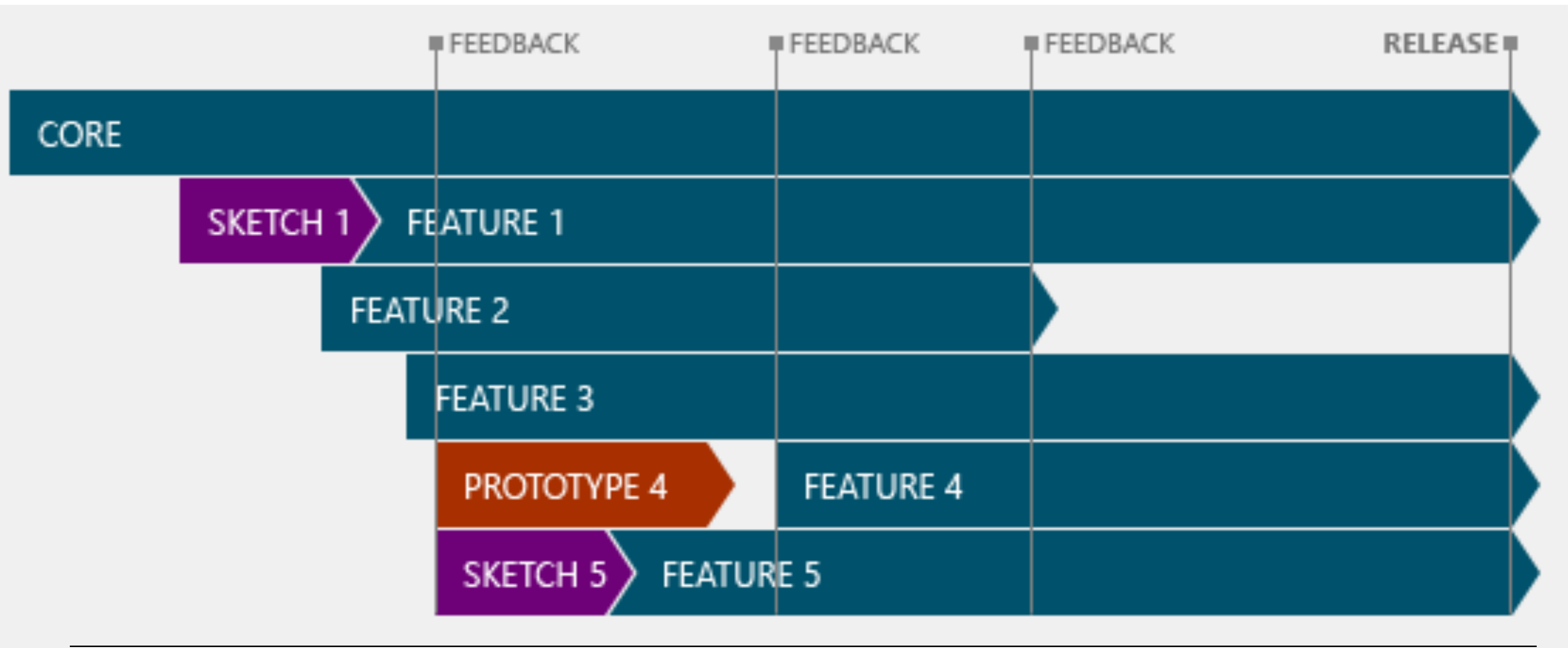

¹⁴ [Image source](#)

Evolutionary prototyping

Definition: Also called *breadboard prototyping*, the design team incrementally builds prototypes of a design idea, tests the idea with users, and refines the prototype until it reaches the desired level of maturity.

Most products we use are evolutionary prototypes that went through alpha, beta, etc. phases.

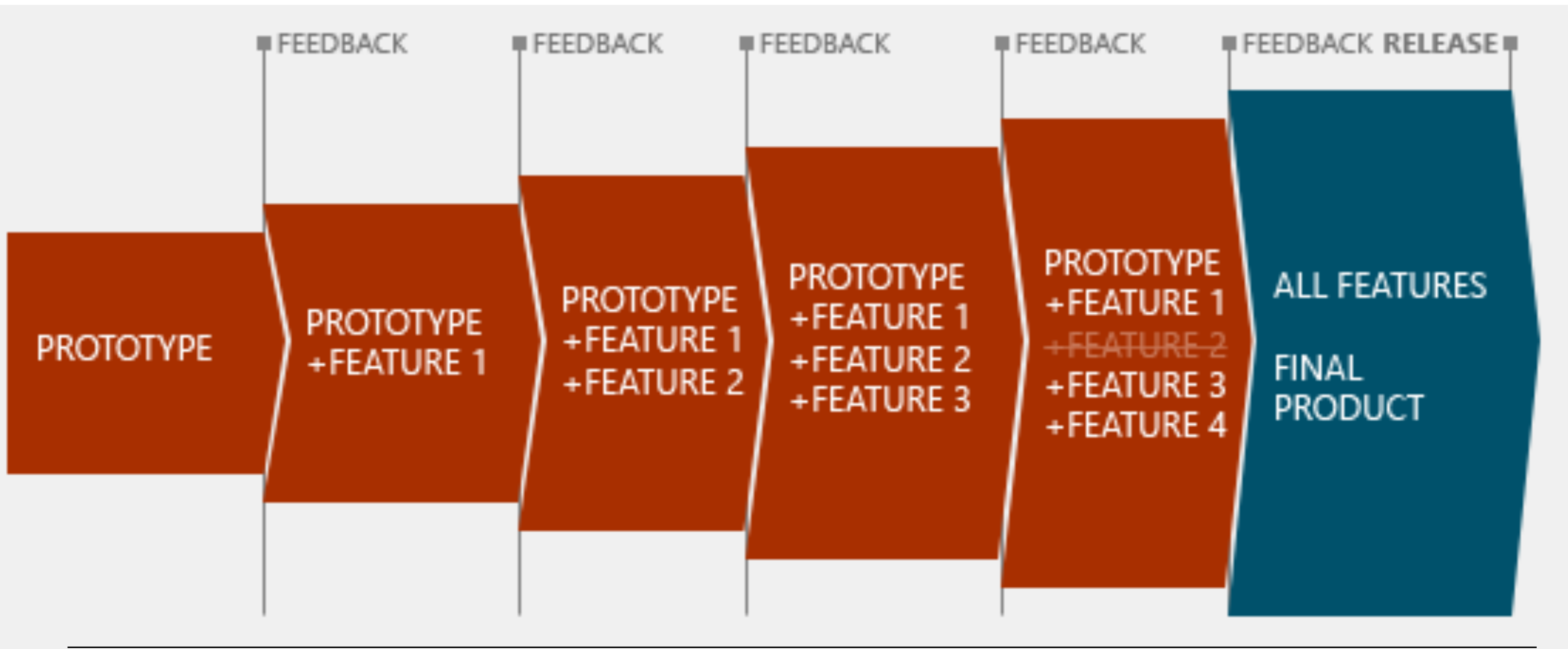

¹⁴ [Image source](#)

Incremental prototyping

Definition: Dividing system functionality into slices (vertical prototypes) based on design specifications and incrementally building each slice that is then integrated into the overall system.

Appropriate for large and complex projects.

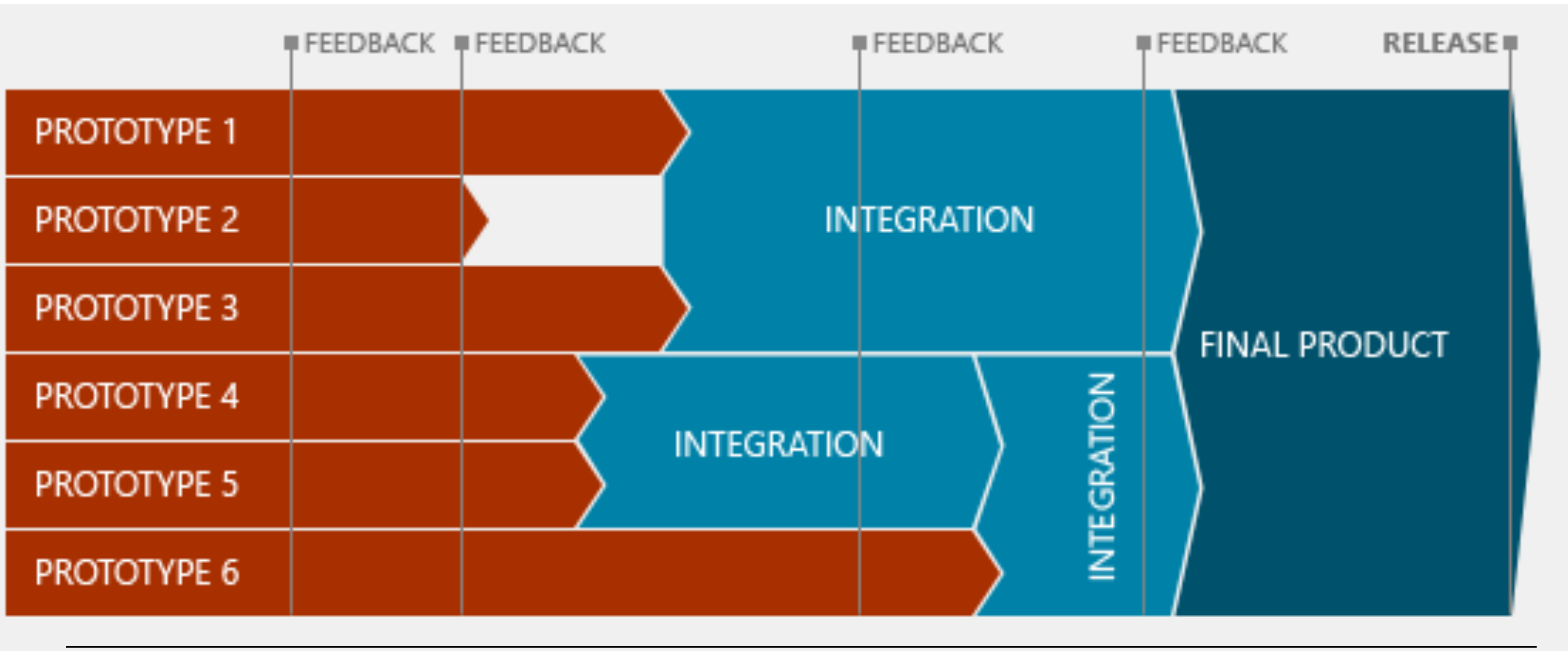

¹⁴ [Image source](#)

Extreme prototyping

Definition: Breaking down the development into three phases that build on each other: (1) building a static prototype, (2) building fully functional, interactive components that will simulate services, and (3) finally implementing the services.

Enables rapid and parallel prototyping, testing, and refinement by removing dependencies between different components of a system or between the system and third party services.

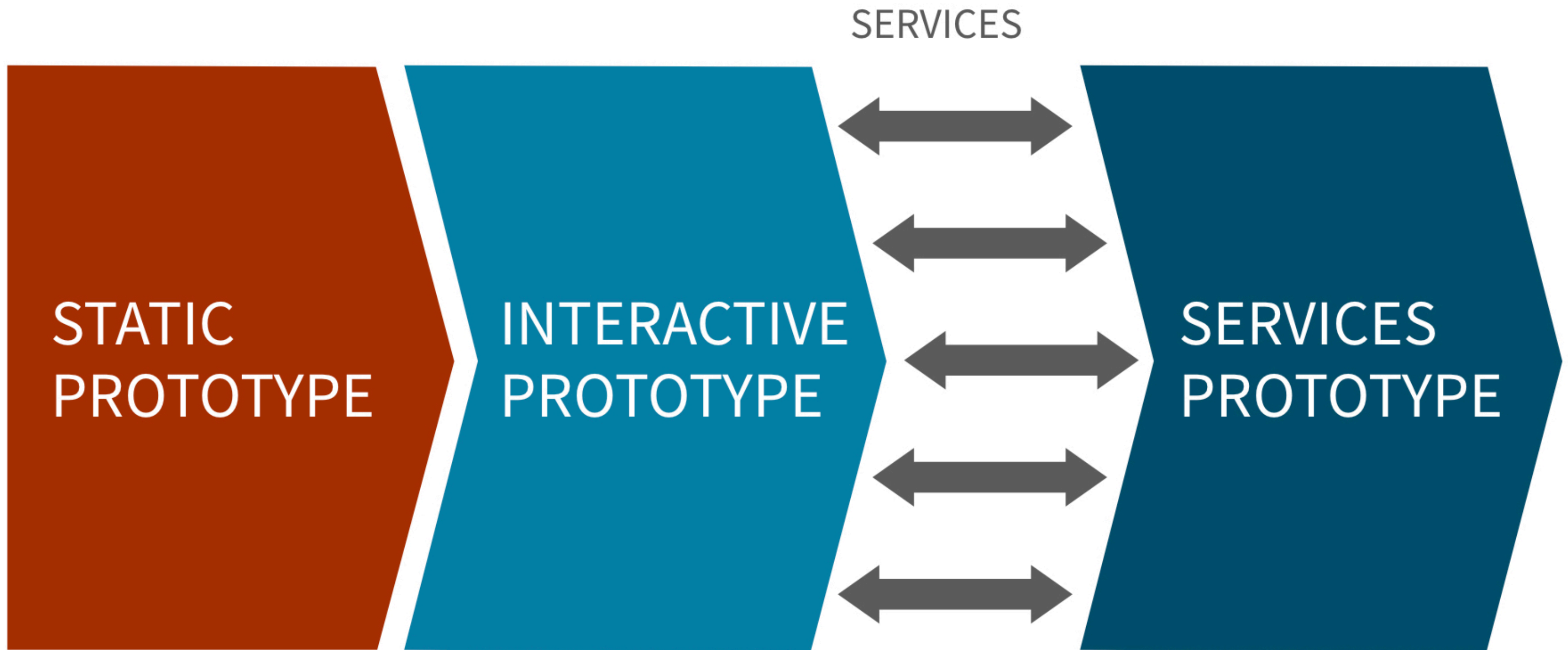

Fidelity in Prototyping¹⁵

Definition: The level of detail in which a design is represented in the prototype.

- >> Two ends of a fidelity spectrum:
 - >> Low-fidelity (lo-fi) prototyping
 - >> High-fidelity (hi-fi) prototyping

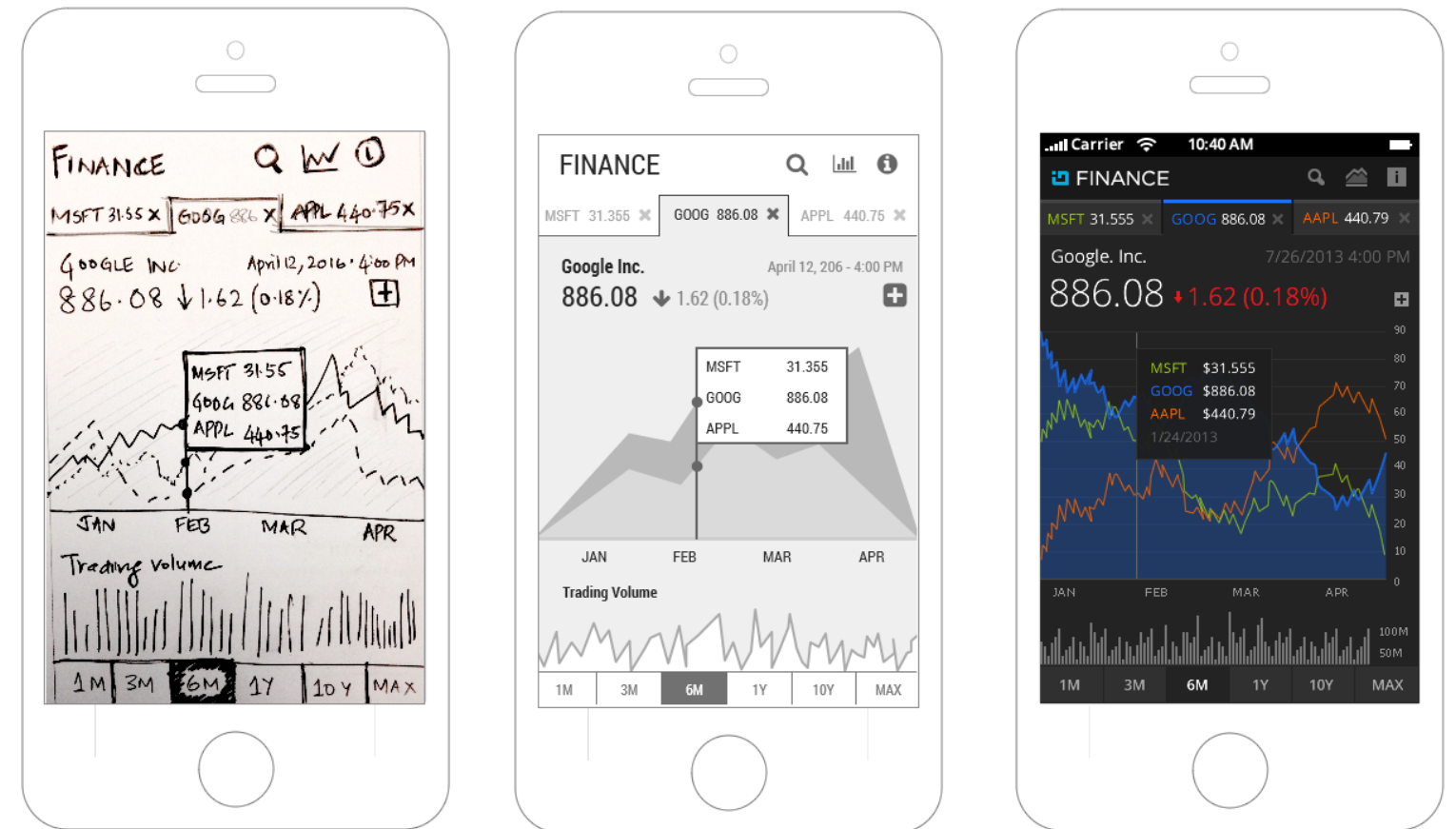

¹⁵ [Image source](#)

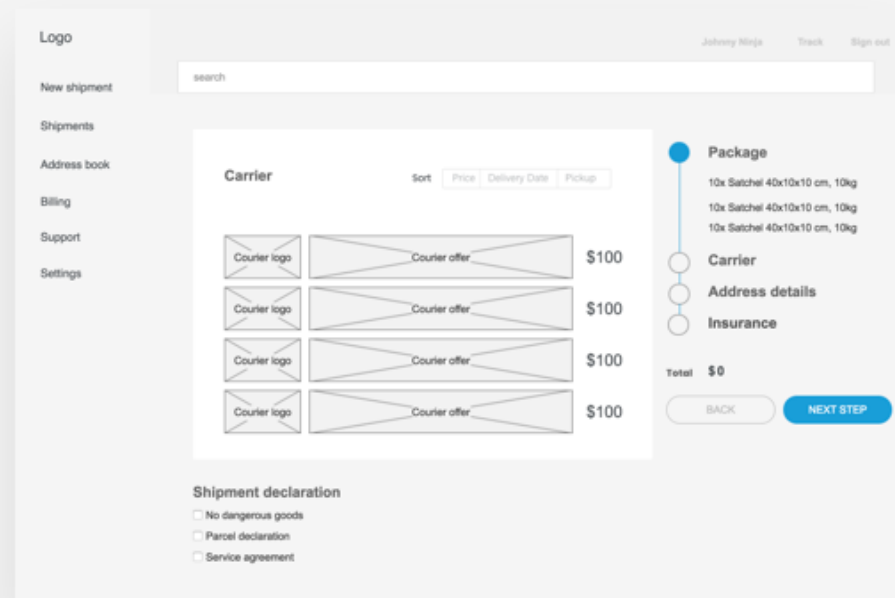

Low-fidelity

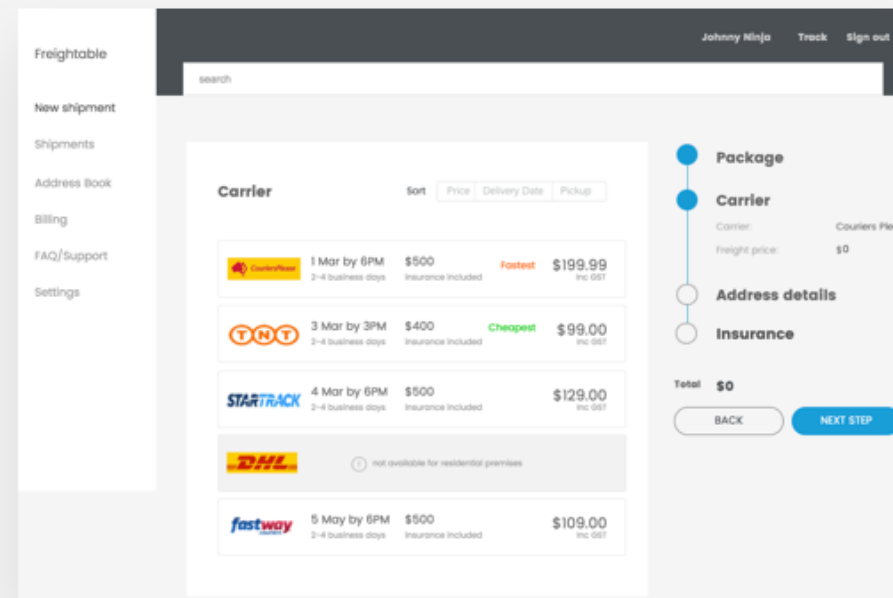

High-fidelity

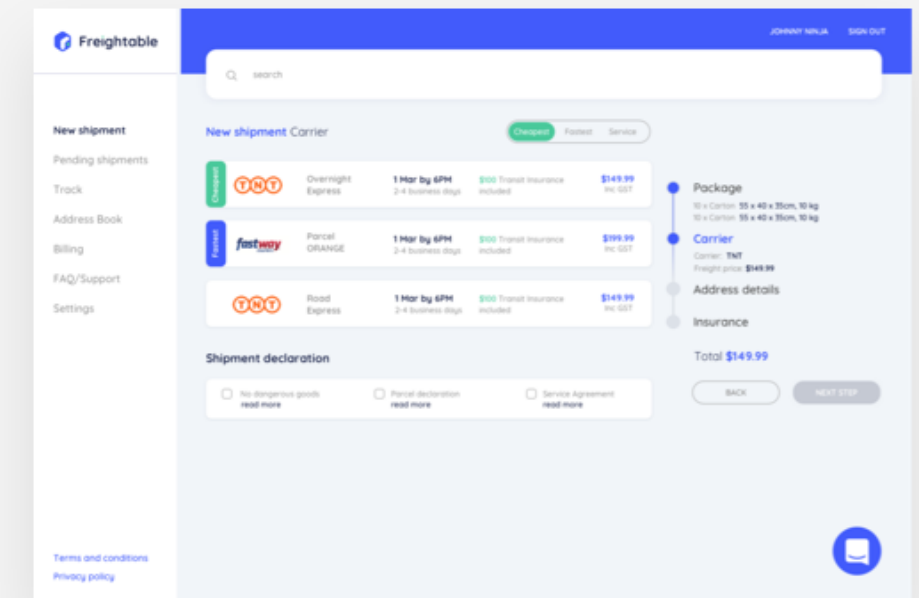

Final design

¹⁶ Image source

Why is fidelity important?¹⁷

The more "done" the prototype looks, the narrower the feedback will be; and vice versa.

This is just an idea. I'm not done!

As a principle, use no higher resolution than is necessary.

¹⁷ Image source: *unknown*



Looks Done
Mocked up in Photoshop, a multimedia program (Director, Flash, etc.), or a GUI builder (NetBeans, Visual Studio, etc.)

"Can you change the font on that 'T'?"
"Not sure I like the bevel line weight.."

Feedback: detailed tweaks to specific features. Very focused and incremental.



Visio, Powerpoint, etc.
Illustrated using a professional drawing or presentation tool.

"I don't like the two-column layout for tools. Can we have them go across the top?"

Feedback: tweaks to the 'screen' or page as a whole. Incremental improvements.



Rough Sketch
Scanned from a hand-drawing, made with a drawing app and a tablet, or using the Napkin Look and Feel skin.

"Maybe the tools should be context-specific... Let's kill the toolbar and bring up only the tools that make sense at that moment.."

Feedback: higher-level features are questioned, bigger changes possible.



Storyboard or Use Case

The "story" of how the user might need or want to interact with the interface (app, book, product, etc.)

"We should NOT try to put a drawing feature in here... it's featuritis without a key benefit to most users."

Feedback: big-picture ideas, possibility for revolutionary changes.

Why bother with lo-fi prototyping?

- >> Has lower development cost
- >> Prevents designers from prematurely wedding to specific design ideas
- >> Enables exploring, communicating, and testing of conceptual designs
- >> Helps designers identify structural, navigation, and organizational issues

Why bother with lo-fi prototyping? *Continued*

- >> Allows rapid evaluation of multiple design ideas
- >> Enables communication among stakeholders
- >> Allows identifying market requirements before dedicating resources to development

Limitations of Lo-fi Prototyping

- >> Requires a facilitator to drive the prototype during testing and communication
- >> Offers limited ability to identify breakdowns in design
- >> Lacks sufficiently low-level specifications for development
- >> Provides limited sense of feasibility

Choosing the Right Method

How do we choose the right method?

- » Various methods, approaches, and strategies for prototyping
- » Criteria for choosing the right method:
 - » Design team goals
 - » Capabilities and resources
 - » Available time for prototyping

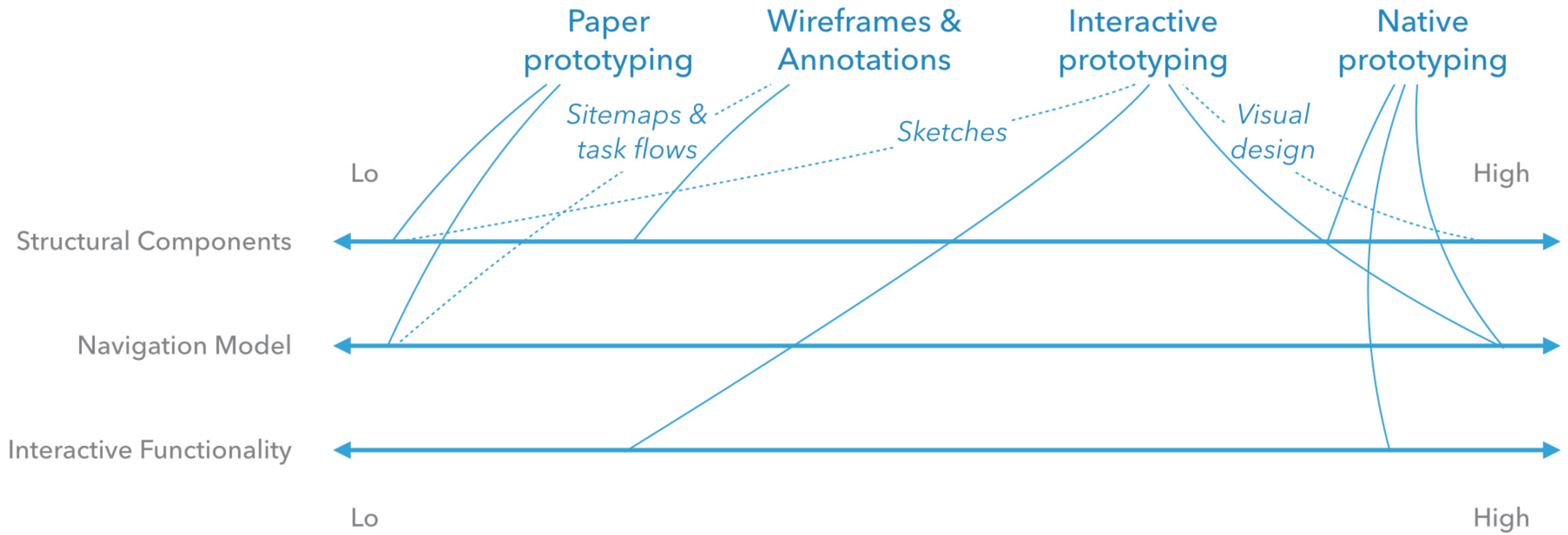

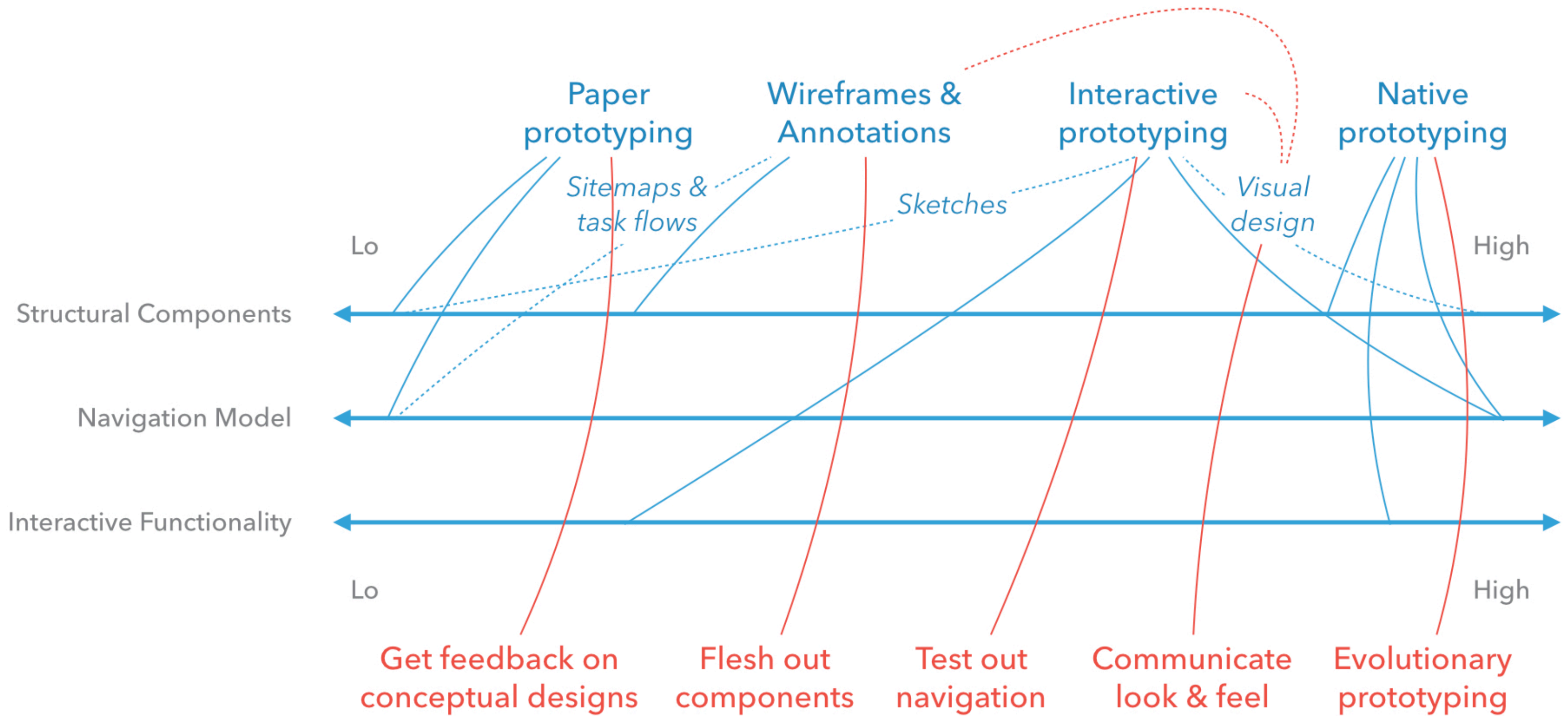

Hands-on Activity

We will paper-prototype user interaction with a *mobile fitness app*:

1. Find a partner (person sitting next to you)
2. Choose from one of the following: (1) logging into the app; (2) logging food; (3) logging exercise; (4) reviewing progress for the past week
3. Think about design elements, components, what will change and be updated, and how you might simulate *visual design* and *navigation/updates*
4. Prototype away!

What did we learn today?

- >> Prototyping methods
- >> Prototyping theory
- >> Choosing the right method
- >> Hands-on activity